



IP Office™ Platform 9.1

9600 Series User Guide

Notice

While reasonable efforts have been made to ensure that the information in this document is complete and accurate at the time of printing, Avaya assumes no liability for any errors. Avaya reserves the right to make changes and corrections to the information in this document without the obligation to notify any person or organization of such changes.

Documentation disclaimer

"Documentation" means information published by Avaya in varying mediums which may include product information, operating instructions and performance specifications that Avaya may generally make available to users of its products and Hosted Services. Documentation does not include marketing materials. Avaya shall not be responsible for any modifications, additions, or deletions to the original published version of documentation unless such modifications, additions, or deletions were performed by Avaya. End User agrees to indemnify and hold harmless Avaya, Avaya's agents, servants and employees against all claims, lawsuits, demands and judgments arising out of, or in connection with, subsequent modifications, additions or deletions to this documentation, to the extent made by End User.

Link disclaimer

Avaya is not responsible for the contents or reliability of any linked websites referenced within this site or documentation provided by Avaya. Avaya is not responsible for the accuracy of any information, statement or content provided on these sites and does not necessarily endorse the products, services, or information described or offered within them. Avaya does not guarantee that these links will work all the time and has no control over the availability of the linked pages.

Warranty

Avaya provides a limited warranty on Avaya hardware and software. Refer to your sales agreement to establish the terms of the limited warranty. In addition, Avaya's standard warranty language, as well as information regarding support for this product while under warranty is available to Avaya customers and other parties through the Avaya Support website: <http://www.avaya.com/support> or such successor site as designated by Avaya. Please note that if you acquired the product(s) from an authorized Avaya Channel Partner outside of the United States and Canada, the warranty is provided to you by said Avaya Channel Partner and not by Avaya.

Licenses

THE SOFTWARE LICENSE TERMS AVAILABLE ON THE AVAYA WEBSITE, [HTTP://SUPPORT.AVAYA.COM/LICENSEINFO](http://SUPPORT.AVAYA.COM/LICENSEINFO), OR SUCH SUCCESSOR SITE AS DESIGNATED BY AVAYA, ARE APPLICABLE TO ANYONE WHO DOWNLOADS, USES AND/OR INSTALLS AVAYA SOFTWARE, PURCHASED FROM AVAYA INC., ANY AVAYA AFFILIATE, OR AN AVAYA CHANNEL PARTNER (AS APPLICABLE) UNDER A COMMERCIAL AGREEMENT WITH AVAYA OR AN AVAYA CHANNEL PARTNER. UNLESS OTHERWISE AGREED TO BY AVAYA IN WRITING, AVAYA DOES NOT EXTEND THIS LICENSE IF THE SOFTWARE WAS OBTAINED FROM ANYONE OTHER THAN AVAYA, AN AVAYA AFFILIATE OR AN AVAYA CHANNEL PARTNER; AVAYA RESERVES THE RIGHT TO TAKE LEGAL ACTION AGAINST YOU AND ANYONE ELSE USING OR SELLING THE SOFTWARE WITHOUT A LICENSE. BY INSTALLING, DOWNLOADING OR USING THE SOFTWARE, OR AUTHORIZING OTHERS TO DO SO, YOU, ON BEHALF OF YOURSELF AND THE ENTITY FOR WHOM YOU ARE INSTALLING, DOWNLOADING OR USING THE SOFTWARE (HEREINAFTER REFERRED TO INTERCHANGEABLY AS "YOU" AND "END USER"), AGREE TO THESE TERMS AND CONDITIONS AND CREATE A BINDING CONTRACT BETWEEN YOU AND AVAYA INC. OR THE APPLICABLE AVAYA AFFILIATE ("AVAYA").

Avaya grants you a license within the scope of the license types described below, with the exception of Heritage Nortel Software, for which the scope of the license is detailed below. Where the order documentation does not expressly identify a license type, the applicable license will be a Designated System License. The applicable number of licenses and units of capacity for which the license is granted will be one (1), unless a different number of licenses or units of capacity is specified in the documentation or other materials available to you. "Software" means Avaya's computer programs in object code, provided by Avaya or an Avaya Channel Partner, whether as stand-alone products, pre-installed, or remotely accessed on hardware products, and any upgrades, updates, bug fixes, or modified versions thereto. "Designated Processor" means a single stand-alone computing device. "Server" means a Designated Processor that hosts a software application to be accessed by multiple users. "Instance" means a single copy of the Software executing at a particular time: (i) on one physical machine; or (ii) on one deployed software virtual machine ("VM") or similar deployment.

Designated System(s) License (DS). End User may install and use each copy or an Instance of the Software only on a number of Designated Processors up to the number indicated in the order. Avaya may require the Designated Processor(s) to be identified in the order by type, serial number, feature key, Instance, location or other specific designation, or to be provided by End User to Avaya through electronic means established by Avaya specifically for this purpose.

Concurrent User License (CU). End User may install and use the Software on multiple Designated Processors or one or more Servers, so long as only the licensed number of Units are accessing and using the Software at any given time. A "Unit" means the unit on which Avaya, at its sole discretion, bases the pricing of its licenses and can be, without limitation, an agent, port or user, an e-mail or voice mail account in the name of a person or corporate function (e.g., webmaster or helpdesk), or a directory entry in the administrative database utilized by the Software that permits one user to interface with the Software. Units may be linked to a specific, identified Server or an Instance of the Software.

Database License (DL). End User may install and use each copy or an Instance of the Software on one Server or on multiple Servers provided that each of the Servers on which the Software is installed communicates with no more than an Instance of the same database.

CPU License (CP). End User may install and use each copy or Instance of the Software on a number of Servers up to the number indicated in the order provided that the performance capacity of the Server(s) does not exceed the performance capacity specified for the Software. End User may not re-install or operate the Software on Server(s) with a larger performance capacity without Avaya's prior consent and payment of an upgrade fee.

Named User License (NU). You may: (i) install and use the Software on a single Designated Processor or Server per authorized Named User (defined below); or (ii) install and use the Software on a Server so long as only authorized Named Users access and use the Software. "Named User," means a user or device that has been expressly authorized by Avaya to access and use the Software. At Avaya's sole discretion, a "Named User" may be, without limitation, designated by name, corporate function (e.g., webmaster or helpdesk), an e-mail or voice mail account in the name of a person or corporate function, or a directory entry in the administrative database utilized by the Software that permits one user to interface with the Software.

Shrinkwrap License (SR). You may install and use the Software in accordance with the terms and conditions of the applicable license agreements, such as "shrinkwrap" or "clickthrough" license accompanying or applicable to the Software ("Shrinkwrap License").

Heritage Nortel Software

"Heritage Nortel Software" means the software that was acquired by Avaya as part of its purchase of the Nortel Enterprise Solutions Business in December 2009. The Heritage Nortel Software currently available for license from Avaya is the software contained within the list of Heritage Nortel Products located at <http://support.avaya.com/LicenseInfo/> under the link "Heritage Nortel Products," or such successor site as designated by Avaya. For Heritage Nortel Software, Avaya grants Customer a license to use Heritage Nortel Software provided hereunder solely to the extent of the authorized activation or authorized usage level, solely for the purpose specified in the Documentation, and solely as embedded in, for execution on, or (in the event the applicable Documentation permits installation on non-Avaya equipment) for communication with Avaya equipment. Charges for Heritage Nortel Software may be based on extent of activation or use authorized as specified in an order or invoice.

Copyright

Except where expressly stated otherwise, no use should be made of materials on this site, the Documentation, Software, Hosted Service, or hardware provided by Avaya. All content on this site, the documentation, Hosted Service, and the Product provided by Avaya including the selection, arrangement and design of the content is owned either by Avaya or its licensors and is protected by copyright and other intellectual property laws including the sui generis rights relating to the protection of databases. You may not modify, copy, reproduce, republish, upload, post, transmit or distribute in any way any content, in whole or in part, including any code and software unless expressly authorized by Avaya. Unauthorized reproduction, transmission, dissemination, storage, and or use without the express written consent of Avaya can be a criminal, as well as a civil offense under the applicable law.

Virtualization

Each product has its own ordering code and license types. Note that each Instance of a product must be separately licensed and ordered. For example, if the end user customer or Avaya Channel Partner would like to install two Instances of the same type of products, then two products of that type must be ordered.

Third Party Components

"Third Party Components" mean certain software programs or portions thereof included in the Software or Hosted Service may contain software (including open source software) distributed under third party agreements ("Third Party Components"), which contain terms regarding the rights to use certain portions of the Software ("Third Party Terms"). As required, information regarding distributed Linux OS source code (for those Products that have distributed Linux OS source code) and identifying the copyright holders of the Third Party Components and the Third Party Terms that apply is available in the Documentation or on Avaya's website at: <http://support.avaya.com/Copyright> or such successor site as designated by Avaya. You agree to the Third Party Terms for any such Third Party Components.

Preventing Toll Fraud

"Toll Fraud" is the unauthorized use of your telecommunications system by an unauthorized party (for example, a person who is not a corporate employee, agent, subcontractor, or is not working on your company's behalf). Be aware that there can be a risk of Toll Fraud associated with your system and that, if Toll Fraud occurs, it can result in substantial additional charges for your telecommunications services.

Avaya Toll Fraud intervention

If you suspect that you are being victimized by Toll Fraud and you need technical assistance or support, call Technical Service Center Toll Fraud Intervention Hotline at +1-800-643-2353 for the United States and Canada. For additional support telephone numbers, see the Avaya Support website: <http://support.avaya.com>, or such successor site as designated by Avaya. Suspected security vulnerabilities with Avaya products should be reported to Avaya by sending mail to: securityalerts@avaya.com.

Trademarks

The trademarks, logos and service marks ("Marks") displayed in this site, the Documentation, Hosted Service(s), and Product(s) provided by Avaya are the registered or unregistered Marks of Avaya, its affiliates, or other third parties. Users are not permitted to use such Marks without prior written consent from Avaya or such third party which may own the Mark. Nothing contained in this site, the Documentation, Hosted Service(s) and Product(s) should be construed as granting, by implication, estoppel, or otherwise, any license or right in and to the Marks without the express written permission of Avaya or the applicable third party.

Avaya is a registered trademark of Avaya Inc.

All non-Avaya trademarks are the property of their respective owners.

Linux® is the registered trademark of Linus Torvalds in the U.S. and other countries.

Downloading Documentation

For the most current versions of Documentation, see the Avaya Support website: <http://support.avaya.com>, or such successor site as designated by Avaya.

Contact Avaya Support

See the Avaya Support website: <http://support.avaya.com> for Product or Hosted Service notices and articles, or to report a problem with your Avaya Product or Hosted Service. For a list of support telephone numbers and contact addresses, go to the Avaya Support website: <http://support.avaya.com> (or such successor site as designated by Avaya), scroll to the bottom of the page, and select Contact Avaya Support.

Contents

1. Introduction

1.1 Important Safety Information.....	11
1.2 9608 Telephone.....	12
1.3 9611 Telephone.....	13
1.4 9620 Telephone.....	14
1.5 9621 Telephone.....	15
1.6 9630 Telephone.....	16
1.7 9640 Telephone.....	17
1.8 9641 Telephone.....	18
1.9 9650 Telephone.....	19
1.10 Button Modules.....	20
1.11 Phone Keys.....	21
1.12 Status Letters.....	22
1.13 Touch Screen Operation.....	22
1.14 The Phone Stand.....	22

2. Making Calls

2.1 En-Bloc Dialing.....	26
2.2 Call Soft Key Options.....	27
2.3 Calling from the Contacts List.....	28
2.4 Calling from the Call Log/History.....	28
2.5 Redialling a Previous Number.....	29
2.6 Making a Page Call.....	29
2.7 Withholding Your Number.....	29
2.8 Adjusting the Call Volume.....	30
2.9 Muting a Call.....	30
2.10 Ending Calls.....	30

3. Answering Calls

3.1 Diverting a Call to Voicemail.....	33
3.2 Ignoring/Silencing an Incoming Call.....	33
3.3 Dropping an Incoming Call.....	33
3.4 Answering a Page Call.....	33
3.5 Using Call Pickup.....	34

4. Redialling

4.1 Open Call Log Mode.....	36
4.2 Last Dialed Mode.....	36
4.3 Selecting Your Redial Mode.....	36

5. Holding and Parking Calls

5.1 Holding Calls.....	39
5.1.1 Holding a Call.....	39
5.1.2 Taking a Call Off Hold.....	39
5.1.3 Switching Between Calls.....	40
5.1.4 Transferring a Held Call.....	40
5.2 Parking Calls.....	41
5.2.1 Parking Calls Using the Menu.....	41
5.2.2 Unparking Calls (Status Menu).....	41
5.2.3 Park & Page.....	42

6. Transferring Calls

6.1 Transferring to Voicemail.....	46
6.2 Transferring a Held Call.....	47
6.3 Transferring a Call to Your Mobile.....	47

7. Account Codes

7.1 Forced Account Code Entry.....	50
7.2 Manual Account Code Entry.....	50

8. Conference Calls

8.1 Starting a Conference.....	52
8.2 Adding a Call to a Conference.....	52
8.3 Viewing Conference Details.....	52
8.4 Dropping/Muting Parties.....	53
8.5 Holding a Conference Call.....	53
8.6 Context Sensitive Conferencing.....	54

9. Headset/Handsfree Operation

9.1 Headset Operation.....	56
9.1.1 Headset Volume.....	57
9.1.2 Default Handsfree Audio Path.....	57
9.1.3 Automatic Gain Control.....	57
9.1.4 Using Bluetooth Headsets.....	58
9.1.5 Headset Alert Sounds.....	58
9.2 Handsfree Speaker Operation.....	59
9.2.1 Speaker Volume.....	60
9.2.2 Default Handsfree Audio Path.....	60
9.2.3 Automatic Gain Control.....	60

10. Contacts/Directory

10.1 Managing External Contacts.....	62
10.2 Viewing Contacts Details.....	63
10.3 Making a Call from the Directory.....	64
10.4 Using the Directory for Other Functions.....	64
10.5 Adding a New Contact.....	65
10.6 Adding a Contact from the Call Log/History.....	65
10.7 Editing a Contact.....	66
10.8 Deleting a Contact.....	66

11. Call History

11.1 Accessing the Call Log/History.....	69
11.2 Making a Call.....	69
11.3 Viewing Call Details.....	70
11.4 Deleting a Record.....	71
11.5 Deleting All Records.....	71
11.6 Adding a Record to Your Contacts.....	71

12. Voicemail

12.1 Message Waiting Indication.....	74
12.2 Visual Voice.....	75
12.3 Checking Messages.....	75
12.4 Sending a Message.....	76
12.5 Email Mode.....	76
12.6 Mailbox Greeting.....	77
12.7 Mailbox Name.....	78
12.8 Changing Your Voicemail Code.....	78
12.9 Switching Voicemail On/Off.....	79
12.10 Transferring to Voicemail.....	79
12.11 Sending a Call to Voicemail.....	79

13. Logging In/Out

13.1 Logging In.....	83
13.1.1 Logging In on a Phone Already in Use.....	83

13.1.2 Logging In on an Unregistered Phone.....	83	16.2.16 Ringer Off.....	110
13.1.3 Logging In on a Not Logged In Phone.....	83	16.2.17 Self Administer.....	110
13.2 Logging Out.....	84	16.2.18 Send All Calls.....	110
13.3 Locking the Phone.....	84	16.2.19 Suppress Digits.....	110
13.4 Auto Lock.....	85	16.2.20 Twinning.....	110
13.5 Unlocking the Phone.....	85	16.2.21 User BLF.....	110
13.6 Changing Your Security PIN.....	85		
14.Redirecting Calls		17.Home Screen	
14.1 Follow Me.....	89	17.1 Editing Your Home Screen.....	115
14.1.1 Follow Me To (Features Menu).....	90	17.2 Abbreviated Dial.....	116
14.1.2 Follow Me (Status Menu).....	90	17.3 Absence Text.....	116
14.1.3 Follow Me Here (Features Menu).....	90	17.4 Auto Intercom.....	116
14.2 Forwarding Calls.....	91	17.5 Call Forward All.....	116
14.2.1 Forward Unconditional (Status Menu).....	93	17.6 Call Pickup.....	116
14.2.2 Forward Unconditional (Features Menu).....	93	17.7 Call Pickup Any.....	116
14.2.3 Forward On Busy/No Answer (Features Menu).....	94	17.8 Page.....	116
14.2.4 Forward On No Answer (Status Menu).....	94	17.9 Self Administer.....	116
14.2.5 Forward On Busy (Status Menu).....	95	17.10 Send All Calls.....	116
14.3 Do Not Disturb.....	96	18.Phone Settings	
14.3.1 DND On/Off (Features Menu).....	97	18.1 Mobile Twinning.....	119
14.3.2 DND Off (Status Menu).....	97	18.2 Withhold Number.....	119
14.3.3 Do Not Disturb Exceptions.....	97	18.3 Redial Mode.....	119
14.4 Twinning.....	98	18.4 En-Bloc Dialing.....	120
14.4.1 Mobile Twinning Control.....	98	18.5 Auto Lock.....	121
14.4.2 Transferring a Call to Your Mobile.....	99	18.6 Ringer Controls.....	121
14.4.3 Reclaiming a Twinned Call.....	99	18.6.1 Disabling the Ringer.....	121
14.4.4 Switching Twinning Off.....	99	18.6.2 Ring Pattern/Sound.....	122
		18.6.3 Visual Alerting.....	124
		18.6.4 Coverage Ring.....	124
		18.6.5 Ringer Volume.....	124
		18.6.6 Internal Auto Answer.....	124
15.Groups		18.7 Display Controls.....	125
15.1 Group Membership.....	103	18.7.1 Display Brightness.....	125
15.1.1 Group Membership On/Off (Status Menu).....	103	18.7.2 Display Contrast.....	125
15.1.2 Group Membership On/Off (Features Menu).....	103	18.7.3 Last Call Duration Display.....	126
15.2 Group Service Status and Fallback.....	104	18.7.4 Home Screen Display.....	126
15.2.1 Changing the Group Service Status (Features Menu).....	105	18.7.5 Call Timer Display.....	126
15.2.2 Changing the Group Service Status (Status Menu).....	105	18.7.6 Display Language.....	126
15.2.3 Changing the Fallback Destinations.....	106	18.7.7 Auto Display Waiting Call.....	127
		18.7.8 Inactivity Timer (Auto Return).....	128
		18.7.9 Quick Touch Lines.....	128
16.Button Features		18.8 Volume and Sound.....	130
16.1 Editing Your Programmable Buttons.....	108	18.8.1 Button Clicks.....	130
16.2 Features.....	108	18.8.2 Error Tones.....	130
16.2.1 Abbreviated Dial.....	109	18.8.3 Ringer Volume.....	130
16.2.2 Absence Text.....	109	18.8.4 Handset Volume.....	131
16.2.3 Account Code.....	109	18.8.5 Headset Volume.....	131
16.2.4 Auto Answer.....	109	18.8.6 Speaker Volume.....	131
16.2.5 Call Forward All.....	109	18.8.7 Automatic Gain Control.....	131
16.2.6 Call Park.....	109	18.8.8 Default Handsfree Audio Path.....	131
16.2.7 Call Park to Other.....	109	18.9 Backup/Restore.....	132
16.2.8 Call Pickup.....	109	18.9.1 Backup.....	132
16.2.9 Call Pickup Any.....	109	18.9.2 Restore.....	132
16.2.10 Conf Meet Me.....	109	18.10 Viewing Information.....	133
16.2.11 Drop Call.....	109		
16.2.12 Flash Hook.....	110	19.Status Menu	
16.2.13 Group BLF.....	110	19.1 Do Not Disturb.....	136
16.2.14 Page.....	110	19.2 Follow Me To.....	136
16.2.15 Park and Page.....	110		

19.3 Follow Me Here.....	137	23.28 Ringing Line Preference.....	165
19.4 Forward On Busy.....	137	23.29 Short Codes.....	165
19.5 Forward On No Answer.....	138	23.30 Small Community Network.....	165
19.6 Forward Unconditional.....	138	23.31 System Administrator.....	165
19.7 Forwarded Here.....	138	23.32 System Phone User.....	165
19.8 Group Membership.....	139	23.33 Twinning.....	165
19.9 Group Service Status.....	139		
19.10 Mobile Twinning.....	139	24.Document History	
19.11 Parked Calls.....	140	Index	169
19.12 System Alarms.....	140		

20.Short Codes

21.System Administration

21.1 Checking the System Information.....	146
21.2 Setting the Date.....	146
21.3 Checking the Time Server Status.....	147
21.4 Setting the Time.....	148
21.5 Setting the Time Offset.....	148
21.6 Shutting Down the System.....	149
21.7 Managing Memory Cards.....	150
21.8 Reporting System Alarms.....	151
21.9 Debug Mode.....	152

22.Menus

22.1 Features Menu.....	154
22.2 Status Menu.....	155
22.3 A Menu	156
22.4 Menu Access Control.....	156
22.5 Entering Characters.....	158

23.Glossary

23.1 Abbreviated Ring.....	162
23.2 Appearance Button.....	162
23.3 Attention Ring.....	162
23.4 Auto Hold.....	162
23.5 Bridged Appearance Button.....	162
23.6 Call Appearance Button.....	162
23.7 Call Coverage Button.....	162
23.8 Coverage Ring.....	162
23.9 Do Not Disturb.....	162
23.10 Do Not Disturb Exceptions.....	163
23.11 Follow Me.....	163
23.12 Follow Me Here.....	163
23.13 Follow Me To.....	163
23.14 Forward on Busy.....	163
23.15 Forward on No Answer.....	163
23.16 Forward Unconditional.....	163
23.17 Group	164
23.18 Idle Line Preference.....	164
23.19 Internal Twinning.....	164
23.20 Line Appearance Button.....	164
23.21 Logged Out.....	164
23.22 Missed Call.....	164
23.23 Missed Group Call.....	164
23.24 Login Code.....	164
23.25 Mobile Twinning.....	165
23.26 Park Call.....	165
23.27 Park Slot Number.....	165

Chapter 1.

Introduction

1. Introduction

This guide is for 9600 Series telephones supported an IP Office telephone system running IP Office Release 9.1 or higher software. It covers phones running H.323 firmware. If unsure if this is the correct guide for your system contact your system administrator.

- **9600 Series Phones**

These IP phones are supported by IP Office and other Avaya telephone systems. The supported phones are:

Phone	Programmable Buttons	Colour Screen	Touch Screen	Gigabit*	Headset	Speaker Phone	Button Module Support
9608 ¹²	24	No	No	No	Yes	Yes	BM12 x 3 SBM24 x 3
9608G ¹²	24	No	No	Yes	Yes	Yes	BM12 x 3 SBM24 x 3
9611G ¹³	24	No	No	Yes	Yes	Yes	BM12 x 3 SBM24 x 3
9620L ¹⁴	24	No	No	No	Yes	Yes	–
9620C ¹⁴	24	Yes	No	No	Yes	Yes	–
9621G ¹⁵	24	Yes	Yes	Yes	Yes	Yes	–
9630G ¹⁶	24	No	No	Yes	Yes	Yes	SBM24 x 3
9640 ¹⁷	24	Yes	No	No	Yes	Yes	SBM24 x 3
9640G ¹⁷	24	Yes	No	Yes	Yes	Yes	SBM24 x 3
9641G ¹⁸ 9641GS ¹⁸	24	Yes	Yes	Yes	Yes	Yes	BM12 x 3 / SBM24 x 3
9650 ¹⁹	24	No	No	No	Yes	Yes	SBM24 x 3
9650C ¹⁹	24	Yes	No	No	Yes	Yes	SBM24 x 3

- **Gigabit Support**

This column indicates that the phone natively supports Gigabit Ethernet. Other phones can support Gigabit through the use of a suitable Gigabit adapter.

- **Unsupported Features**

The 9600 Series phones are supported on a number of Avaya telephone systems and support different features depending on the telephone system. This guide covers only the features supported on an IP Office telephone system.

1.1 Important Safety Information

! Warning: This handset may pick up small metal objects such as metal pins or staples.

- During a power surge, EFT (Electronically Fast Transients), or ESD (Electrostatic Discharge), calls may be dropped. After a power surge, EFT or ESD, it is normal for the phone to restart.
- Using a cell phone, mobile phone, GSM phone or two-way radio in close proximity to an Avaya telephone might cause interference.
- The phone should not be connected directly to the outdoor telecommunication network.

1.2 9608 Telephone

The IP Office supports the 9608 and 9608G telephones. The latter support Gigabit ethernet.

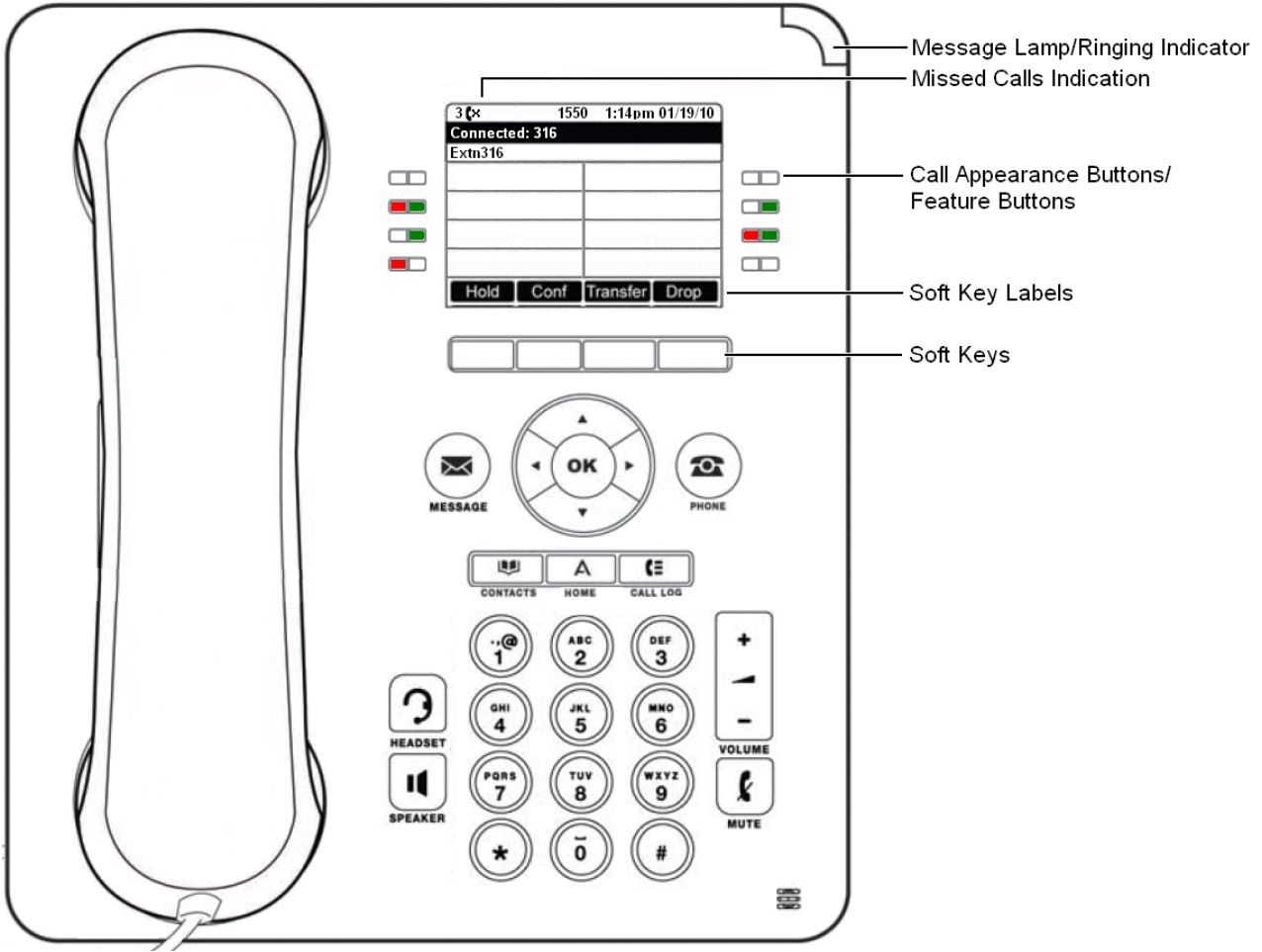

This phone supports 24 programmable call appearance/feature buttons. The labels for these buttons are visible on the main display and can be controlled by the adjacent buttons.

Functions can be assigned to the phone's feature buttons by your system administrator or by yourself using self-administration. Note how you cannot replace features assigned to buttons by your system administrator but you can replace other features. Note also that there are features that the system administrator can assign that are not available for you to assign. This guide includes only the features that are available for you to assign if required.

1.3 9611 Telephone

The IP Office supports the 9611G telephone.

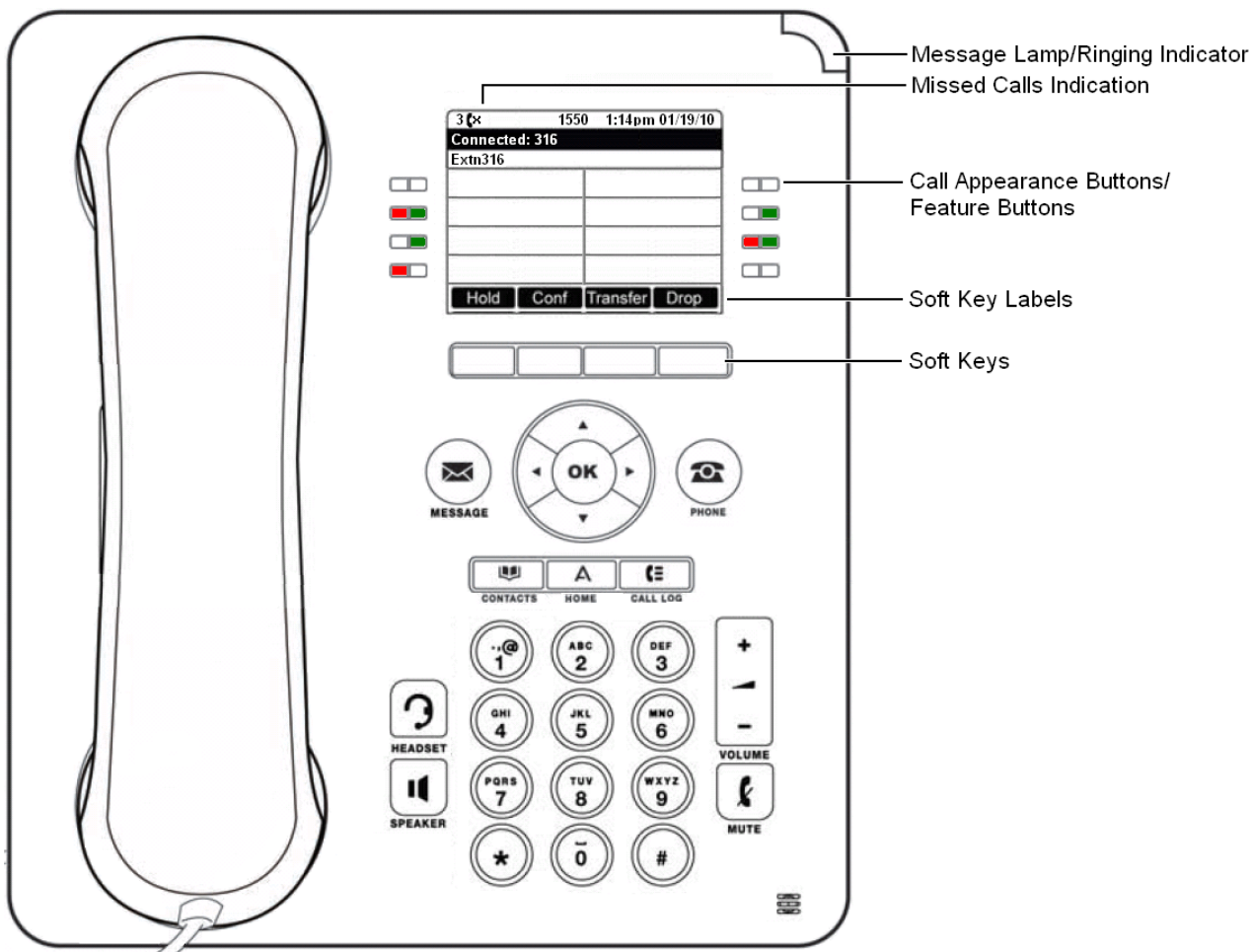

This phone supports 24 programmable call appearance/feature buttons. The labels for these buttons are visible on the main display and can be controlled by the adjacent buttons.

Functions can be assigned to the phone's feature buttons by your system administrator or by yourself using self-administration. Note how you cannot replace features assigned to buttons by your system administrator but you can replace other features. Note also that there are features that the system administrator can assign that are not available for you to assign. This guide includes only the features that are available for you to assign if required.

1.4 9620 Telephone

The IP Office supports the 9620L and 9620C versions of the 9620 telephone.

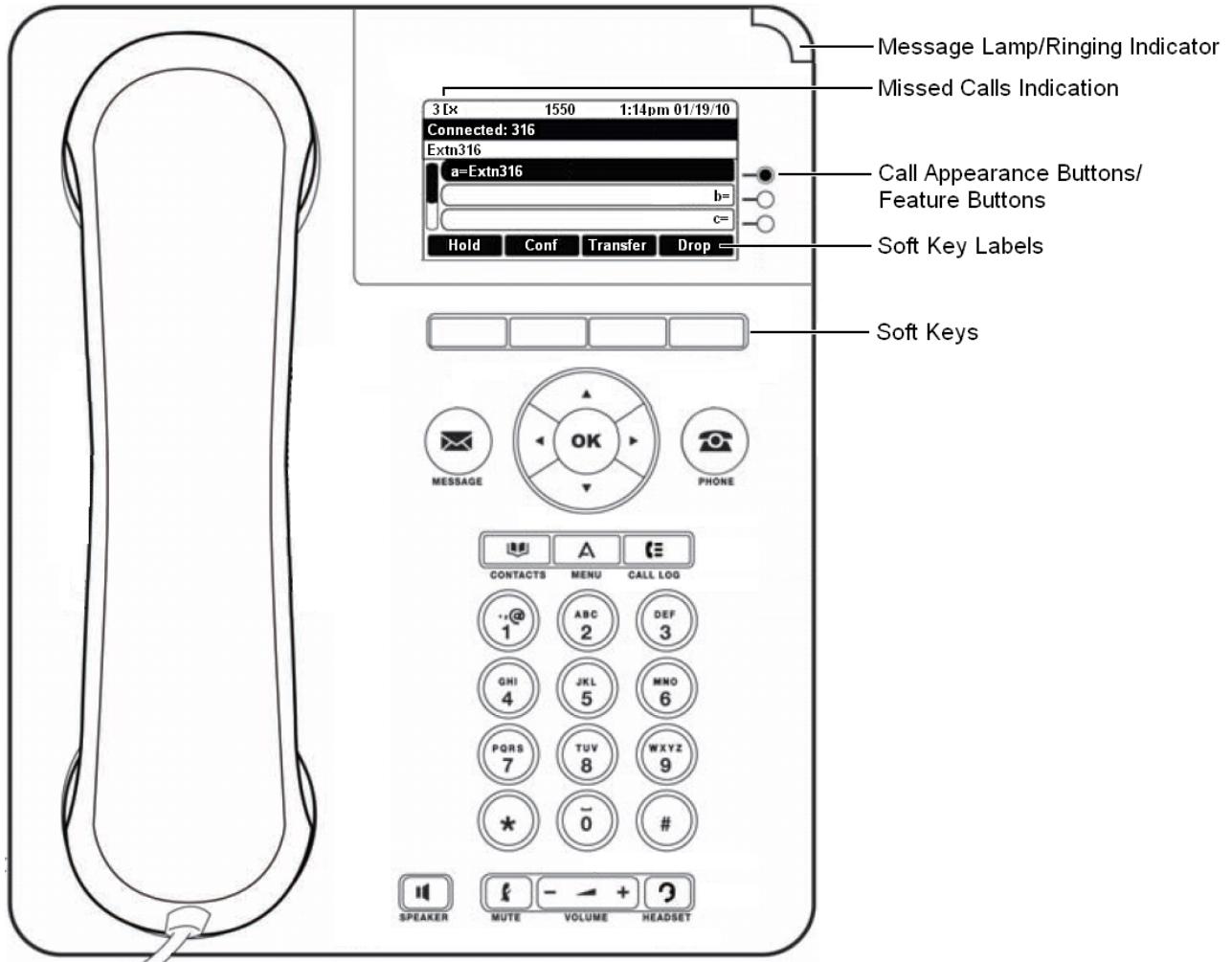

This phone supports 12 programmable call appearance/feature buttons. The labels for 3 of these buttons are visible on the main display and can be controlled by the adjacent buttons to the right. You can use the ▲ up and down ▼ arrow keys to scroll the display. You can also use the ◀ left and right ▶ arrow keys to move through the button features in pages of 3.

Functions can be assigned to the phone's feature buttons by your system administrator or by yourself using self-administration. Note how you cannot replace features assigned to buttons by your system administrator but you can replace other features. Note also that there are features that the system administrator can assign that are not available for you to assign. This guide includes only the features that are available for you to assign if required.

1.5 9621 Telephone

The IP Office supports the 9621 telephone.

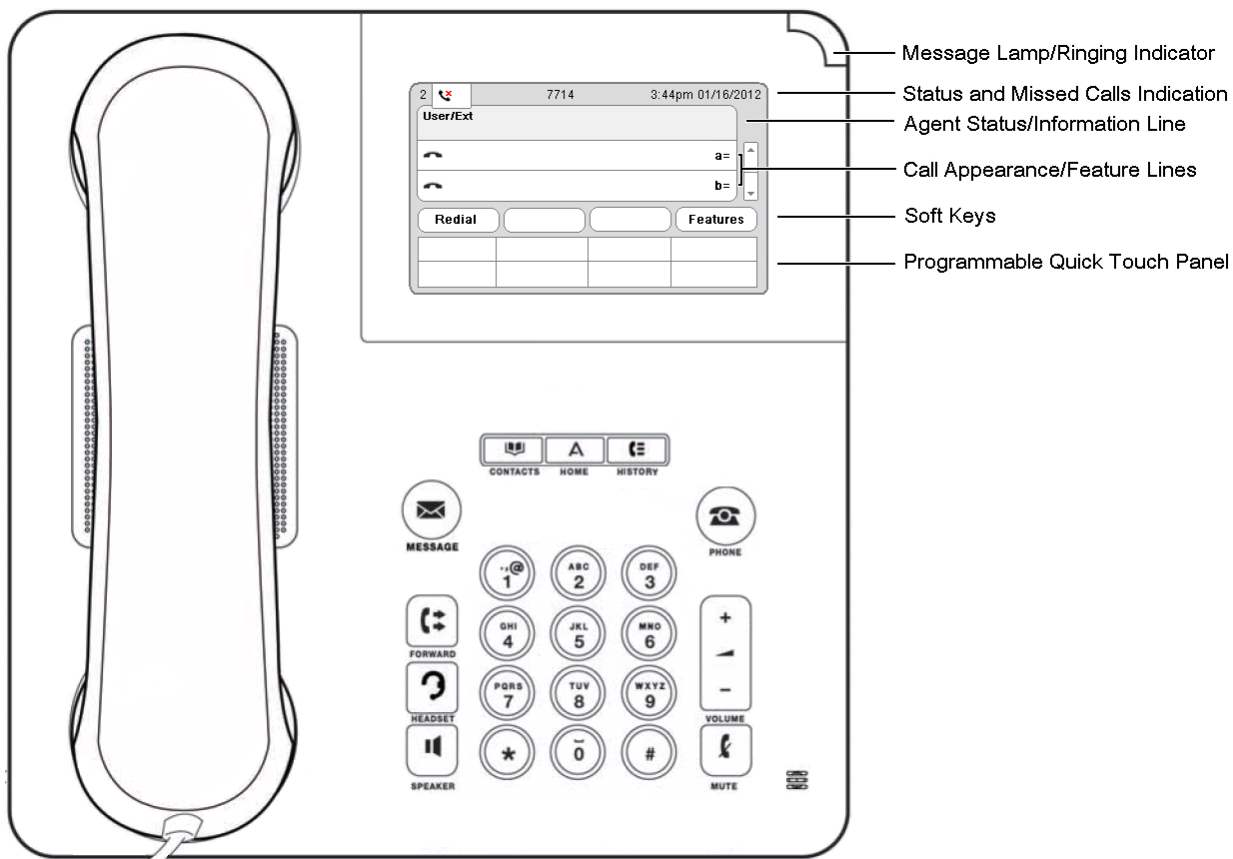

- Message Lamp/Ringing Indicator
- Status and Missed Calls Indication
- Agent Status/Information Line
- Call Appearance/Feature Lines
- Soft Keys
- Programmable Quick Touch Panel

This phone supports 24 programmable call appearance/feature buttons. The labels for 6 of these buttons are visible on the main display and can be controlled by the adjacent buttons to the right. You can use the ▲ up and ▼ down arrow keys to scroll the display. You can also use the ◀ left and right ▶ arrow keys to move through the button features in pages of 6.

Functions can be assigned to the phone's feature buttons by your system administrator or by yourself using self-administration. Note how you cannot replace features assigned to buttons by your system administrator but you can replace other features. Note also that there are features that the system administrator can assign that are not available for you to assign. This guide includes only the features that are available for you to assign if required.

1.6 9630 Telephone

The IP Office supports the 9630G version of the 9630 telephone.

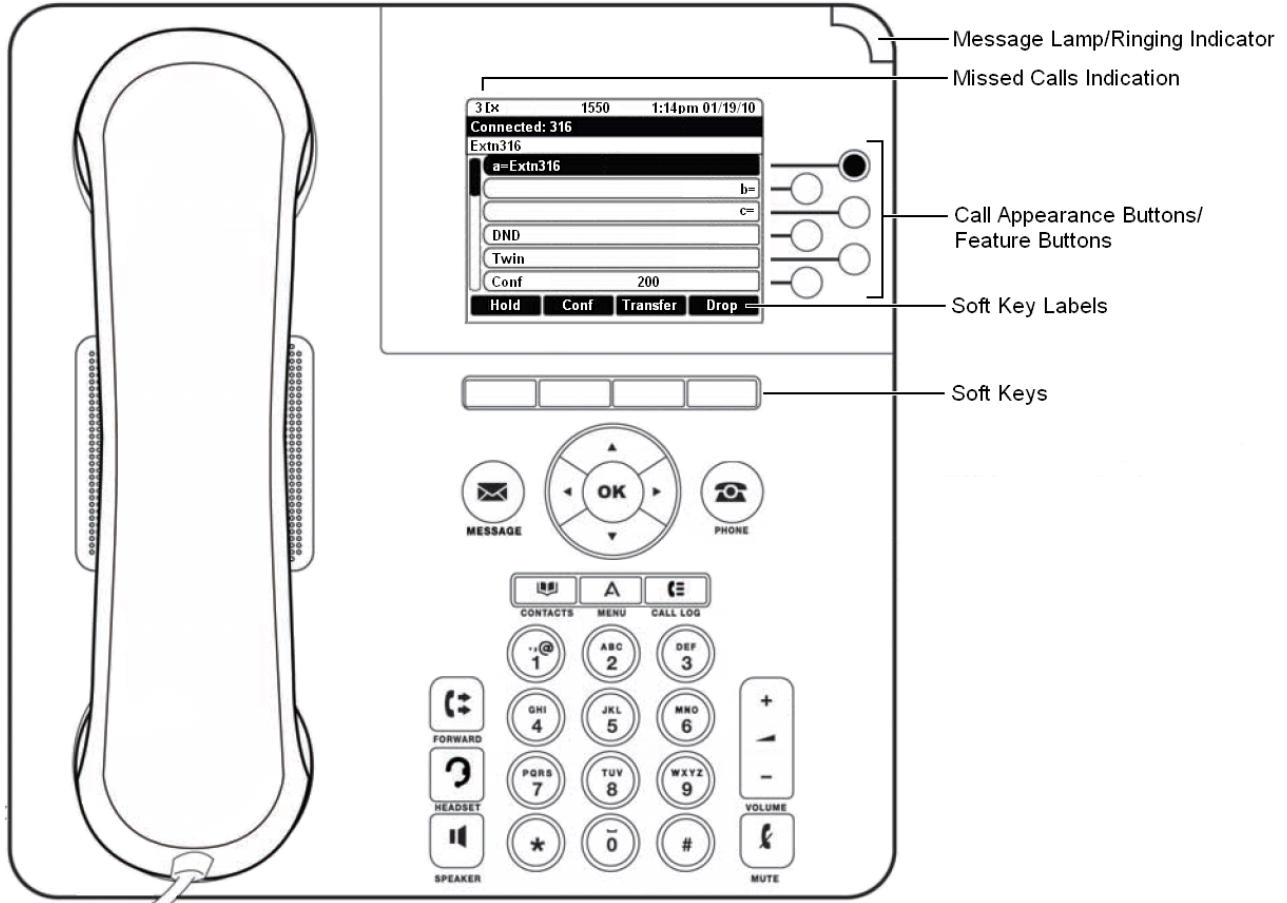

This phone supports 24 programmable call appearance/feature buttons. The labels for 6 of these buttons are visible on the main display and can be controlled by the adjacent buttons to the right. You can use the ▲ up and down ▼ arrow keys to scroll the display. You can also use the ◀ left and right ▶ arrow keys to move through the button features in pages of 6.

Functions can be assigned to the phone's feature buttons by your system administrator or by yourself using self-administration. Note how you cannot replace features assigned to buttons by your system administrator but you can replace other features. Note also that there are features that the system administrator can assign that are not available for you to assign. This guide includes only the features that are available for you to assign if required.

1.7 9640 Telephone

The IP Office supports the 9640 and 9640G versions of the 9640 telephone.

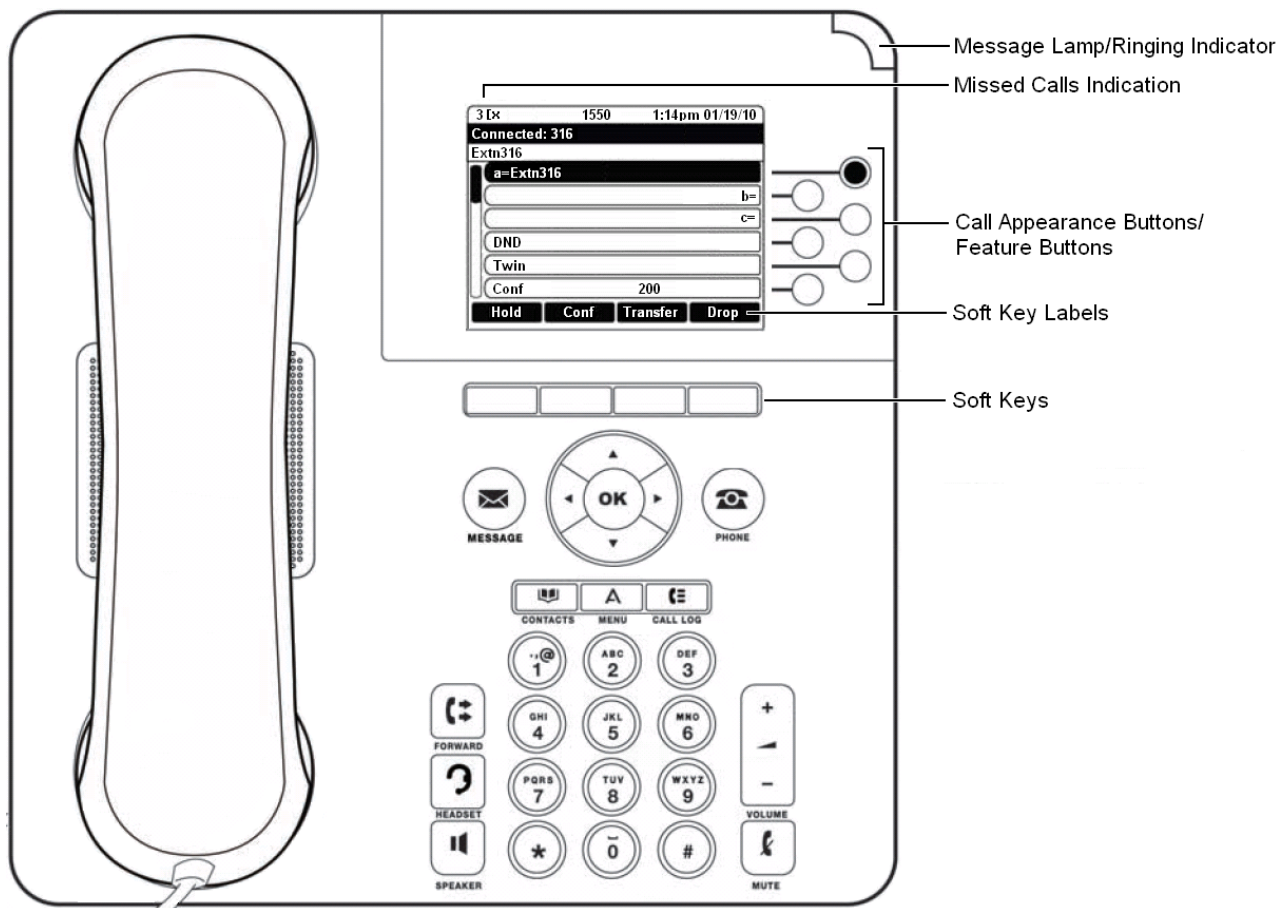

This phone supports 24 programmable call appearance/feature buttons. The labels for 6 of these buttons are visible on the main display and can be controlled by the adjacent buttons to the right. You can use the ▲ up and ▼ down arrow keys to scroll the display. You can also use the ◀ left and right ▶ arrow keys to move through the button features in pages of 6.

Functions can be assigned to the phone's feature buttons by your system administrator or by yourself using self-administration. Note how you cannot replace features assigned to buttons by your system administrator but you can replace other features. Note also that there are features that the system administrator can assign that are not available for you to assign. This guide includes only the features that are available for you to assign if required.

1.8 9641 Telephone

The IP Office supports the 9641G and 9641GS telephones.

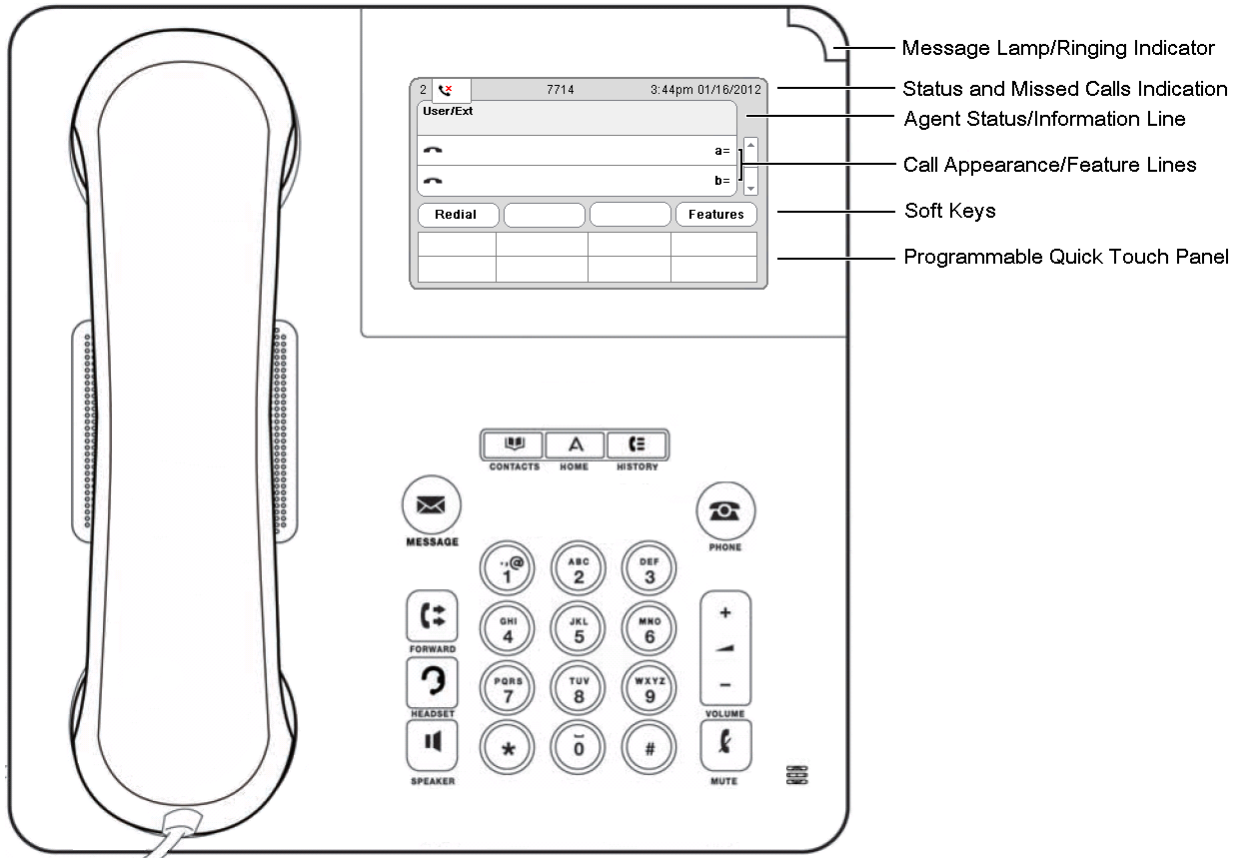

This phone supports 24 programmable call appearance/feature buttons. The labels for these are displayed in the scrollable main display along with icons for the status of the buttons.

In addition, some features can be accessed using the fixed buttons displayed at the bottom of the screen. Through the phone's own menus you can select whether to display one row of four, two rows of two, or no fixed buttons at the bottom of the display.

Functions can be assigned to the phone's feature buttons by your system administrator or by yourself using self-administration. Note how you cannot replace features assigned to buttons by your system administrator but you can replace other features. Note also that there are features that the system administrator can assign that are not available for you to assign. This guide includes only the features that are available for you to assign if required.

1.9 9650 Telephone

The IP Office supports the 9650 and 9650C versions of the 9650 telephone.

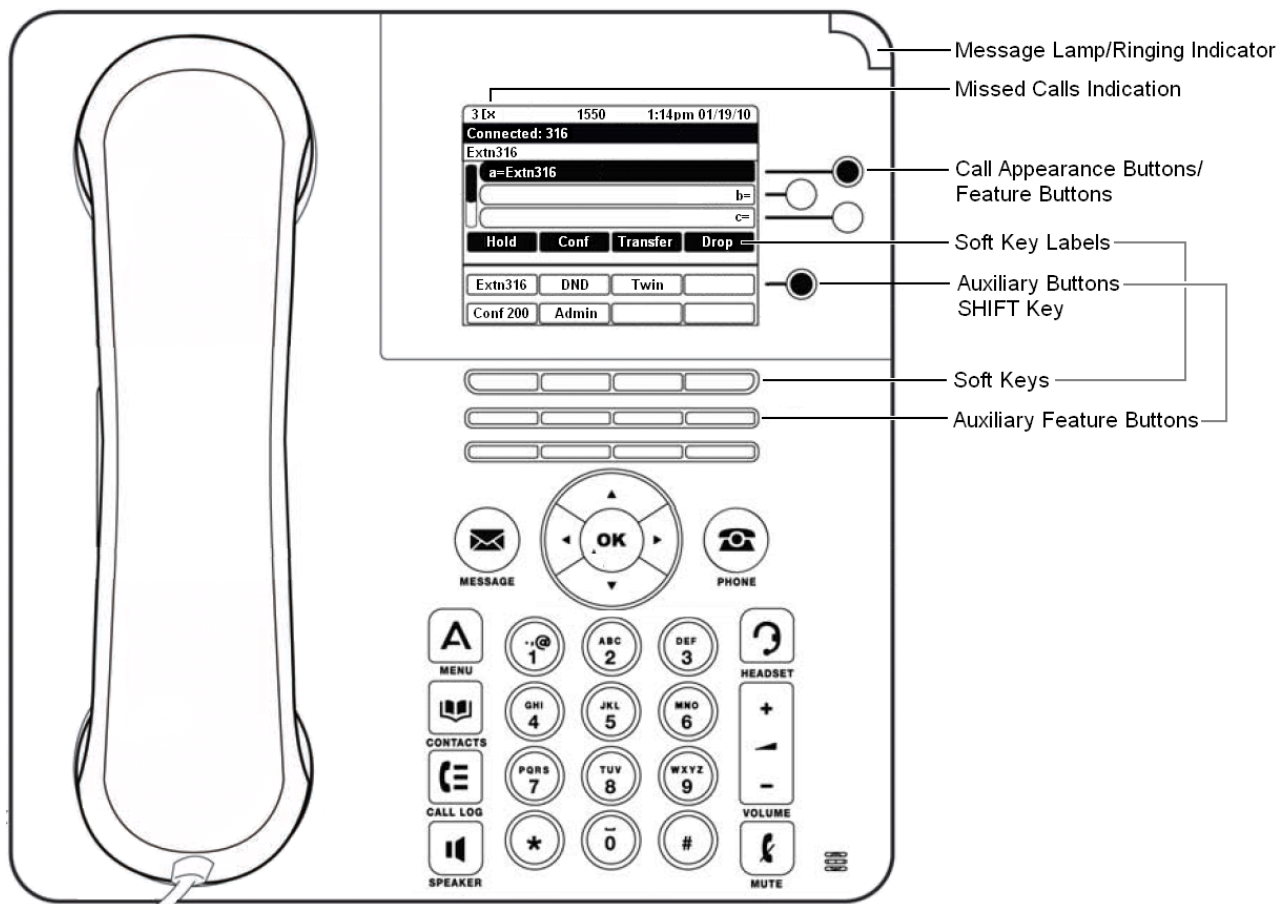

This phone supports 24 programmable call appearance/feature buttons. The labels for 3 of these buttons are visible on the main display and can be controlled by the adjacent buttons to the right. You can use the ▲ up and down ▼ arrow keys to scroll the display. You can also use the ◀ left and right ▶ arrow keys to move through the button features in pages of three.

In addition, the features for 16 of the 24 buttons (buttons 04 to 11 and 12 to 19) can be accessed as using the auxiliary feature buttons below the display. They are shown in two pages of eight with the **SHIFT** key next to the display used to switch between which page is being displayed at any time.

Functions can be assigned to the phone's feature buttons by your system administrator or by yourself using self-administration. Note how you cannot replace features assigned to buttons by your system administrator but you can replace other features. Note also that there are features that the system administrator can assign that are not available for you to assign. This guide includes only the features that are available for you to assign if required.

1.10 Button Modules

The addition of a button module allows the phone to support additional programmable buttons.

- Do not connect or disconnect a button module yourself. Your system administrator will arrange this if necessary. Failure to connect and restart the equipment in the correct order may cause the phone and or the button module to function incorrectly.

9608 and 9641 Phones

These phones support BM12 button modules. Each button module provides the phone with an additional 24 buttons (2 pages of 12) which can be used as [appearance buttons](#)^[162] and or [feature buttons](#)^[108]. These phone can also support SBM24 modules instead (see below) but not a mix of different module types.

Up to three button modules can be attached to each phone. However, the number of button modules supported by the telephone system may be limited by the total number of button modules attached to other phones on the telephone system.

When used with additional equipment the phone power switch should be moved to the **H** position. Note that this make the phone a Class 3 device regardless of the actual power use.

9630, 9640, and 9650 Phones

All variants of these phones support SBM24 button modules. Each button module provides the phone with an additional 24 buttons which can be used as [appearance buttons](#)^[162] and or [feature buttons](#)^[108].













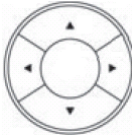

Up to three button modules can be attached to each phone. However the number of button modules supported by the telephone system may be limited by the total number of button modules attached to other phones on the telephone system.

9620 Phones and 9621 Phones

These phones do not support any additional button modules.

1.11 Phone Keys

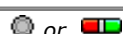





The following keys are found on the phone:

Key	Description
	Soft Keys - The keys below the display have variable functions. When the key is active, its function is indicated by the text label above it. On touch screen phones the labels on the screen can be pressed.
	Message - This key is used to access your voicemail system. By default this uses a series of menus on your phone's display.
	Navigation Keys - Press the ▲ up and down ▼ arrow keys to scroll through lists. In some menus, you can also use the ◀ left and right ▶ arrow keys to enter and exit different levels of the menu. A menu option that accesses a sub-menu is indicated by the ... dots (ellipsis) icon after its name.
	OK - The OK key normally matches the function offered by the leftmost soft key below the screen.
	PHONE - This key is used to exit any menu you are in and return to the appearance buttons menu. During a call it can also be used to toggle the options displayed on the appearance menu.
	MENU/HOME - This key is used to access a menu for phone settings and information.
	CONTACTS ^[62] - This key is used to display the various directories (personal and shared) of names and telephone numbers to which you have access.
	CALL LOG ^[68] / HISTORY ^[71] - This key displays a record of your most recent calls (answered, missed, and outgoing). The button is illuminated when you have new missed calls.
	VOLUME ^[130] - Press + plus or – minus on the Volume key to adjust the volume of the incoming call. Separate volumes can be adjusted for the ringer, handset, headset, and speaker.
	HEADSET ^[56] - This key is used to answer and end calls using a headset connected to the phone's headset socket. The button is lit when you are connected to a call using the headset.
	MUTE ^[30] - This key can be used to mute your speech to the currently connected call. The button is lit while mute is active.
	SPEAKER ^[59] - This key is used to answer and end calls using the phone's handsfree speaker and microphone. The button is lit when you are connected to a call handsfree.
	FORWARD ^[88] - This button provides direct access to the forwarding ^[88] menu options. This button is not present on the 9620 and 9650 models.
 or 	These keys have two roles: <ul style="list-style-type: none"> • Appearance Keys - These buttons represent calls that you can make or receive. • Feature Buttons ^[100] - Those keys not configured as appearance keys can be used for other functions. • On touch screen phones, these buttons are replaced by their text labels on the screen.

- The **CONFERENCE**, **DROP**, **HOLD**, **REDIAL** and **TRANSFER** keys found on other Avaya phones are presented as [soft key](#) ^[27] functions relative to the current call.

Status Indication Icons

The status indication line displays the following icons:

Key	Description
	The speaker icon is visible when you adjust the volume ^[130] while using the handsfree speaker.
	The handset icon is visible when you adjust the volume ^[130] while using the handset.
	The headset icon is visible when you adjust the volume ^[130] while using the headset.
	The bell icon is visible when you adjust the ringer volume ^[130] . A red 'x' appears over the bell icon when you mute the ringer volume.
	This icon is visible anytime you press the  button.
	This icon indicates missed calls ^[164] and is prefixed with the number of missed calls (the icon appears slightly different on 9608 series phones).

1.12 Status Letters

When your own extension name is shown on the second line of the display, for example when the phone is idle, the name may be followed by a series of letters. These letters are used to indicate your current status.

- **B = Barred**

A **B** is shown on your phone's display when the system administrator has prohibited you from making outgoing calls. You will only be able to make internal calls when your status is set to Barred.

- **D = Diverting (Forwarding) Calls**

A **D** is shown after your extension name on the phone's idle display when you have 'forward unconditional' enabled.

- **G = Group Member (In Group)**

A **G** is shown after your extension name on the phone's idle display when you have been configured as a member of a hunt group and your membership is enabled. With this status active, you may receive calls targeted to the hunt group.

- **N = No Calls (Do Not Disturb)**

An **N** is shown after your extension name on the phone's idle display when you have 'do not disturb' enabled.

- **O = Out of Service**

When a group is set to night service mode, all members of that group retain an 'out of service' status indicated by an **O** on the idle display. Calls are diverted to the group's fallback, if set. Otherwise, the calls are sent to voicemail (if available).

- **R = Resilience**

An **R** is shown after your extension name on the phone's idle display to indicate that your phone is working in resilience mode. This is used when there may have been a problem with the telephone system to which your phone was registered and another system is currently providing support for your phone. In this mode, some features may not be available and calls may be routed differently.

- **S = System Alarm**

If you are configured as a [system administrator](#)^[14b], an **S** in the phone's display indicates a [system alarm](#)^[15t].

- **T = Twinned**

A **T** is shown after your extension name on the phone's idle display if it is internally twinned with your phone. Calls to you will alert on both phones and can be answered by you at either phone.

1.13 Touch Screen Operation

The 9621 and 9641 phones use touch sensitive screens to replace many of the buttons required on other phones. These are pressure sensitive and can be operated with either your finger(s) or a stylus. However, you must take care not to use any device that may scratch or cause wear to the screen.

Unlike other phones in the range (where you need to highlight an option on the screen using the arrow keys and then select that option using the **Select** soft key), on a touch screen you can simply press the required option directly.

1.14 The Phone Stand

The phones all include a stand that clips to the base of the phone. The stand allows the phone to be used in either of two different angles.

When changing the position of the stand, be sure to check that the stand has locked into the chosen position. A small plastic peg is located just under the phone's handset. This peg can be reversed to more securely anchor the handset when the stand places the phone in an upright position.

9608 Phones

The stand cannot be flipped to another position except by removing it to change the position. The angle of the display is not adjustable on these phones.

Other 9600 Phones

Once attached, the stand can be used in either position to change the angle of the phone. The angle of the phone can also be adjusted as shown below. The angle of the display can also be adjusted.

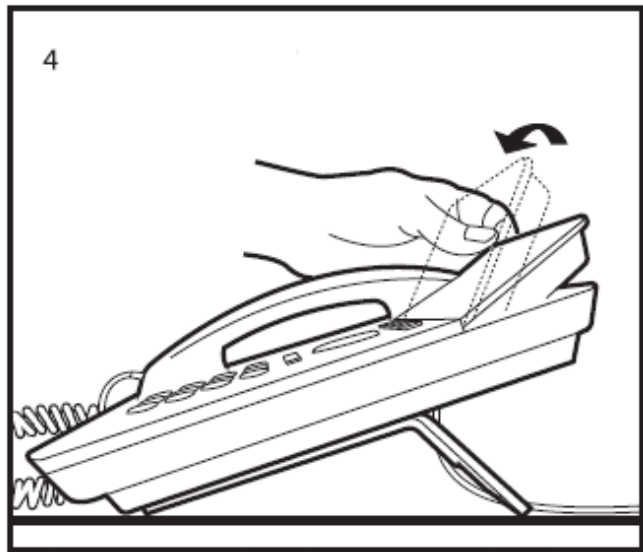
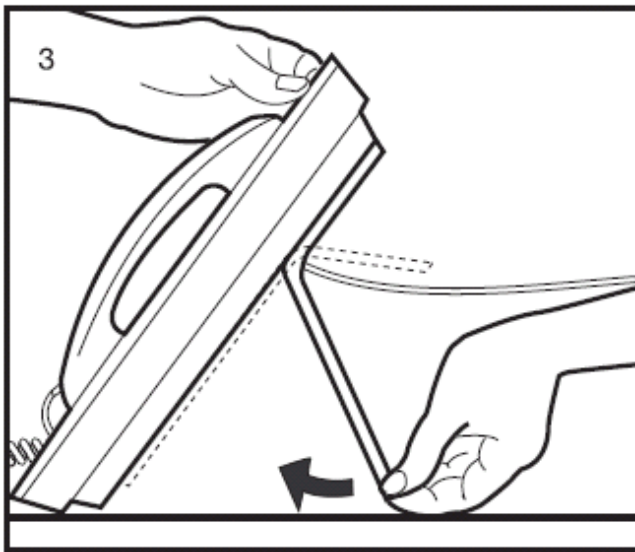
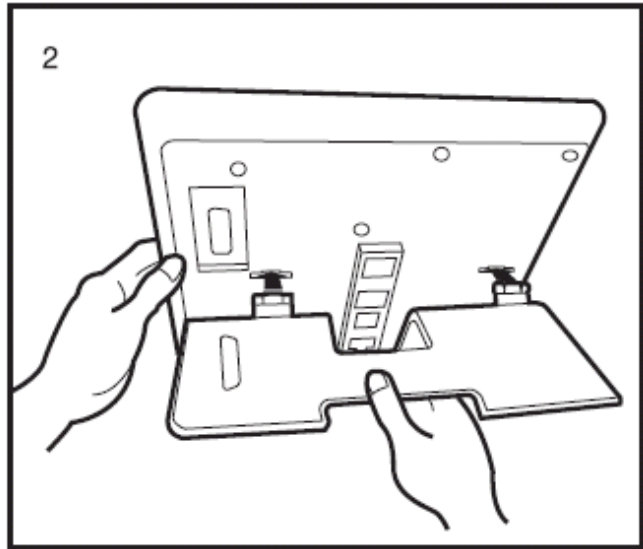
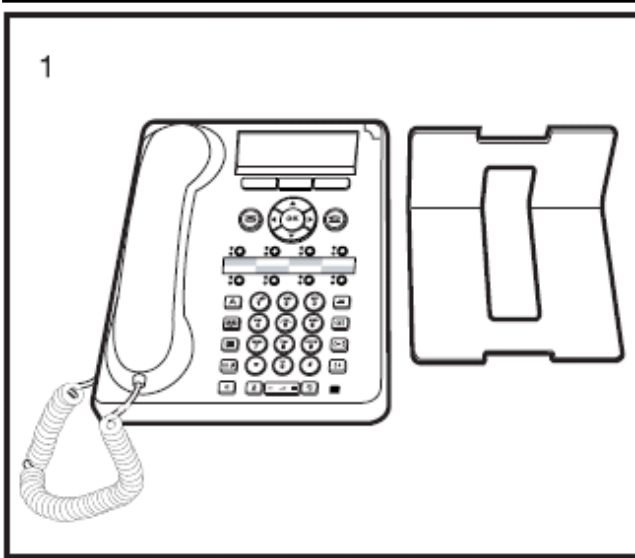

Other Stands

If the phone needs to be used in a situation other than on a desk, for example wall-mounted, a number of other stand designs are available from Avaya. Contact your system administrator.

Chapter 2.

Making Calls

2. Making Calls

If you are not already on a call, then you can just dial the number. The first available appearance button will be used for the call. Alternatively, you can press a specific appearance button in order to make a call using that button.

If the number you dial matches a user or group on the telephone system, the directory name of the user or group is shown and the call starts altering the target.

If the call is to a user, and they do not answer, you can set a callback by pressing **CallBack** and then ending the call by pressing **Drop**. When a callback is set, the next time a user uses their phone or ends their current call, the system will call you and when you answer, automatically make another call to the user.

2.1 En-Bloc Dialing

By default, when you start dialing a number on your phone, the phone immediately connects to the telephone system and starts passing the digits you dial to the phone system. You cannot correct the digits you have already dialed except by ending the call and starting over. Also, if you pause dialing for too long the phone system may think that you have finished dialing and will attempt to connect the call using only the digits you had dialed up to that point.

En-bloc dialing allows you to compose and edit the number to dial on your phone's display before it is sent to the phone system to be dialed.





Through the phone's menus you can select whether you want to use traditional or en-bloc dialing when making calls. Your chosen setting is then applied whenever you use a phone that supports en-bloc dialing.

Dialing a Number Using En-Bloc Mode

1. With no connected call on the phone, start dialing. Do not lift the handset or select headset or speaker before dialing.
2. You can use the  left arrow key or the **Bksp** key to delete the previous digit dialed if you need to correct the number or press **Clear** to erase the whole number.
3. When you have completed the number, you can select how you want to make the call:
 - Lift the handset to make a call using the handset.
 - Press the **Call** soft key or **OK** button to start the call using the phone's [default handsfree audio path](#)^[13] (speaker or headset). You can also press one of your idle call appearance buttons to make the call using that appearance.
 - Press the **Headset** button to start the call on a headset connected to your phone.
 - Press the **Speaker** button to start the call on your phone's handsfree speaker.

Enabling/Disabling En-Bloc Dialing

You can enable or disable your en-bloc dialing setting through the phone's **Features** menu.

1. Press the **Features** soft key if shown. To do this during a call, press the  **PHONE** key and then press the **Features** soft key.
2. Use the  up and down  arrow keys to highlight **Call Settings**. Press **Select**.
4. Use the  up and down  arrow keys to highlight **En-Bloc Dial**.
5. Use **Change** button to select **On** or **Off**.

2.2 Call Soft Key Options

The options displayed for the buttons at the bottom of the display will change dynamically to reflect actions that you can perform during calls or while the phone is idle.

Some or all of these options will only be available if enabled by your system administrator.

- **Account**
Enter an account code to associate with the call.
- **Answer**
Answer a page call, turning it into a normal call.
- **Callback**
Set an automatic callback on the user that you have called but who has not answered. When they next end a call, the telephone system will call you and when answered, will automatically make a call to the user.
- **Complete**
Complete the transfer of a held call. A **Cancel** option is also shown which will end the transfer attempt.
- **Conference**
Put your current call on hold and present dial tone for you to dial the number you want to add to a conference with the held caller.
- **Connect**
Take a call off hold.
- **Dir**
Access the directory in order to select a number by name rather than dialing it. The type of names available in the directory is adjusted to match those suitable for use by the feature.
- **Drop**
End the call.
- **Ignore**
Silence the ringer for the current alerting call. The call will continue alerting until either answered, it goes to voicemail, or the caller abandons the call.
- **Pickup**
Answer the call that is held or alerting another user.
- **Redial**
If there are outgoing numbers in your call log, display the list of those numbers.
- **Transfer**
Put your current call on hold and present dial tone for you to dial the number to which you want to transfer the call.
- **ToVM**
Send an alerting call to your voicemail.

2.3 Calling from the Contacts List

You can use any directory contact to make a call. You can also use the directory in almost any telephone function where you need to select the number for a destination, for example during a transfer.

1. Access the contacts directory:

a. Press the  **CONTACTS** key. The directory menu is displayed.

b. Use the ◀ left and right ▶ arrow keys to select which type of directory entries you want to display.

- **All**
All directory entries.
- **External**
Directory entries stored by the telephone system for all users to use.
- **Groups**
The names and numbers of hunt groups on the telephone system.
- **Users**
The names and numbers of other users on the telephone system.
- **Personal**
Your own personal directory entries.

c. Use the ▲ up and down ▼ arrow keys to scroll through the list. Alternatively you can start dialing the name you want to find to display only matching entries as follows:

- Pressing a button enters all of the characters represented by that button. Pressing another button adds the characters from that button as the next possible characters. For example, dialing **527** simultaneously match all names starting with **JAS** (for example "Jason") and with **KAR** (for example "Karl") plus any other letter combinations from those buttons.
- The characters represented by each dialing pad button depend on the language used by your telephone system. See [Entering Characters](#) ^[158].
- To remove all the characters entered so far press **Clear**.

d. To view more details of the highlighted name, press **Details**. To return to the directory press **List**.

2. When the required entry is highlighted, press **Call** or press the  button next to the name.

3. Proceed as you would with a normally dialed call.



2.4 Calling from the Call Log/History

You can use the call log to make calls to the number included in the currently selected call record.

1. Access the call log.

a. Press the  **HISTORY** button.

b. The display will change to show your call log records. The caller's name is shown if known, otherwise the number. If you have any new missed call records, the button is illuminated and the call log will open showing your missed calls.

c. Use the ◀ left and right ▶ arrow keys to select which call log records you are viewing. The options are **All**, **Outgoing** , **Incoming**  and **Missed** . On touch screen phones, press the icon for the type of call log records you want to display.

d. Use the ▲ up and down ▼ arrow keys to scroll through the records.

2. Press **Call** to call the number displayed in the call record.

2.5 Redialling a Previous Number

When **Redial** is displayed it can be used in one of two ways, set by the phone's [redial mode setting](#)^[36].

List Mode

This redial method is used when your phone's [redial mode](#)^[36] is set to **List**.

1. Access the redial list.
 - a. Press **Redial**. The list of outgoing calls is displayed.
 - b. Use the ▲ up and down ▼ arrow keys to scroll through the 10 most recent outgoing calls.
2. Press **Call** to call the number displayed in the call record.
3. Continue in the same way as for a normal dialed call.

One Number Mode

This redial method is used when your phone's [redial mode](#)^[36] is set to **One**.

1. Press **Redial**.
2. The number for the most recent outgoing call in your personal call log is redialed.
3. Continue in the same way as for a normal dialed call.

2.6 Making a Page Call

In order to make page calls you must have access to a paging short code provided by the system administrator or to a paging feature button.

If the dialing short code or the paging button have been pre-configured with a number, the user or group at that number will be paged if available.

The dialing short code can be configured to accept the number of the user or group to page when dialed. Similarly a paging button can be set to allow number entry when pressed as follows:

1. Press the paging button.
2. Dial the number of the user or group you want to page.
3. When the dialing is completed, the page call is made.
 - If the destination is a user and they already have a call connected, they cannot be paged. If the destination is a group which is not in service or has no available members, it cannot be paged.

Feature Button

If enabled by your system administrator, the self-administer function can be used to assign a feature button as a page button using the Group Paging action.

2.7 Withholding Your Number

You can select to withhold your number on external calls. Note that this option may not be supported in all situations. It may depend on the configuration of your phone system and options supported by your telephone line provider.

1. Press the **Features** soft key if shown. To do this during a call, press the  **PHONE** key and then press the **Features** soft key.
2. Use the ▲ up and down ▼ arrow keys to highlight **Call Settings**. Press **Select**.
3. Use the ▲ up and down ▼ menu keys to highlight **Withhold Number**.
4. Press **Change** to switch the option **On** or **Off**.
5. Press **Save**.

Access Control

Your system administrator can configure whether you can access this menu option. See [Menu Access Control](#)^[156].

2.8 Adjusting the Call Volume



While talking, you can adjust the volume of the incoming call. The volume is adjusted separately for whichever device is in use ([handset](#)^[13†], [headset](#)^[13†] or [speaker](#)^[13†]).

1. With the call connected, press the  **VOLUME** key.
2. Use the + plus and – minus keys to adjust the volume.
3. The display will return to normal after a few seconds.

2.9 Muting a Call



Muting a call stops the caller from hearing you. However you can still hear them. The status indication line indicates a mute setting via the  icon.

- The mute setting remains active even if you switch between calls using hold and or appearance buttons.
- If you change how you are listening to the call, for example switching from the handset to the speaker, the mute setting is canceled.

1. To activate mute, press the  **MUTE** key. The button will be lit while mute is active.
2. To switch mute off, press the  **MUTE** key again.

2.10 Ending Calls

The **Drop** option can be used to end the currently highlighted call on the display.

- If the call is connected on the phone's speaker, the  **SPEAKER** key is lit. Pressing the key again will end the call.
- If the call is connected on the phone's headset, the  **HEADSET** key is lit. Pressing the key again will end the call.
- If the call is connected on the phone's handset, replacing the handset will end the call.

Chapter 3.

Answering Calls

3. Answering Calls

A slow flashing red lamp on an appearance button indicates an alerting call. This may also be accompanied by [ringing](#)^[12] and by the [message lamp flashing](#)^[12].

Selected Button

If you are currently not on a call, you can answer the alerting call in the following ways:

1. Select the method which you want to use to talk to the caller:
 - To silence the ringing, press the **Ignore** soft key. The call will still continue alerting visually and can be answered or ignored.
 - To redirect the call to voicemail, press the **To VM** soft key.
 - To answer the call using the handset, lift the handset.
 - To answer the call handsfree, press the **SPEAKER** key.
 - To answer the call on a headset, press the **HEADSET** key.
 - Just pressing the call appearance key will answer the call either on the speaker or headset depending on the phone's [audio path](#)^[57] setting.
2. Once you have answered the call, you can switch between different talk modes:
 - To switch to using the handset, lift the handset.
 - To switch to handsfree, press the **SPEAKER** key. If you were using the handset you can now safely replace it.
 - To switch to headset mode, press the **HEADSET** key. If you were using the handset you can now safely replace it.
 - If you have answered the call on the speaker or headset, pressing the **SPEAKER** or **HEADSET** key again before you select another mode will end the call.
 - Just pressing the call appearance key or any other appearance button will put the current call on hold.

Answering Another Call

If you are already on a call, answering a new call will automatically put the existing call on hold^[1], unless your first press **Drop**.

1. Using the ▲ up and down ▼ arrow keys, scroll the display highlight the waiting call.
 - To silence the ringing, press the **Ignore** soft key. The call will still continue alerting and can be answered or ignored.
 - To redirect the call to voicemail, press the **To VM** soft key.
2. To answer the call, press the call appearance button. Your existing call will be put on hold.

Note: This guide assumes that auto hold is enabled (the default). The system administrator can disable auto hold for the system, in which case calls are automatically disconnected rather than held.

3.1 Diverting a Call to Voicemail

You can transfer a call targeted at you directly to your voicemail mailbox.

To divert a call to your mailbox:

1. If the call is not the currently highlighted call on the display, use the ▲ up and down ▼ arrow keys to highlight it.
2. Press the **To VM** soft key. The call is redirected to your mailbox.

3.2 Ignoring/Silencing an Incoming Call

You can silence the ringer of a currently alerting call. The call will continue alerting visually but with no audible ring.

To ignore (silence) an incoming call:

1. If the call is not the currently highlighted call on the display, use the ▲ up and down ▼ arrow keys to highlight it.
2. Press the **Ignore** soft key. The call will continue alerting but with no audible ring.

3.3 Dropping an Incoming Call

You can attempt to drop an incoming call. Dropping a call has different effects depending on the call type and other options:

- If the call is a hunt group call, dropping the incoming call causes it to be presented to the next agent in the group or follow other hunt group settings (which can include presenting the call to you again).
- If the call is a direct call to you, dropping it causes it to:
 - Go to your forward on no answer destination if set and enabled. See [Forward On Busy/No Answer](#)⁹⁴.
 - Else the call goes to your voicemail if available.
 - Else the call continues to ring (drop has no effect).
- If the call is returning from being held or parked for too long you cannot drop it.

To drop an incoming call:

1. If the call is not the currently highlighted call on the display, use the ▲ up and down ▼ arrow keys to highlight it.
2. Press the **Drop** key. Depending on your particular phone this may be a soft key on the display or a physical key. You can also assign the drop function to a [programmable key](#)¹⁰⁸.

3.4 Answering a Page Call

Your phone can be paged if you have no other connected call in progress and your phone is currently idle. You can hear the caller but they cannot hear you.

The page is heard through the phone's speaker following a single beep. A page call is also indicated in the display by the word **Page**.

To answer a page call:

- To answer the page call, press the **Answer** key. The call is turned into a normal call. You can continue handsfree or pickup the handset.

To silence a page call:

- To ignore the page call, press the **Drop** key.

3.5 Using Call Pickup

Pickup is used to answer a call ringing elsewhere on the phone system.

To pickup a call:

1. Press the **Features** soft key if shown. To do this during a call, press the  **PHONE** key and then press the **Features** soft key.
2. Use the ▲ up and down ▼ arrow keys to highlight **Pickup**. Press **Select**.
 - To answer a ringing call, press the **Any** soft key.
 - To answer a call ringing against a particular target, dial the target's number. Alternatively, press the **Dir** soft key to [select the target from the directory](#) ^[64].
3. The following menu will appear depending on the type of number entered:
 - **User Number**
 - To answer a call ringing against the user, press the **Pickup** soft key.
 - To return to entering a number, press the **Clear** key.
 - **Hunt Group Number**
 - To answer a call ringing against the members of the group, press the **Members** soft key. The call does not have to be a call to the hunt group.
 - To answer a call ringing for the hunt group, press the **Group** soft key.
 - To return to entering a number, press the **Clear** key.

Access Control

Your system administrator can configure whether you can access this menu option. See [Menu Access Control](#) ^[156].

Default Short Codes

Short codes are numbers that you can dial to enable and disable various features. The following are default short codes that may be available. However, your system administrator can remove and change the short codes available to you or all users.

- **Pickup Any Call: *30**
Answer a call ringing on the telephone system.
- **Pickup a Group Call: *31**
Answer a call ringing a group of which you are a member. You can use this even if your group membership is currently set to disabled.
- **Pickup a Users Call: *32*N#**
Pickup a call ringing a user's extension number (*N*).
- **Pickup a Group Members Call: *53*N#**
Pickup a call ringing the members of a group (*N*). This does not necessarily have to be a group call.

Chapter 4.

Redialling

4. Redialling

The phone's redial operation can work in either of the following modes:

- **Open Call Log** ^[36]
If this mode is selected, pressing **Redial** will display a menu of the most recent outgoing calls in your call log. You can select the call that you want to redial and perform a number of other functions.
- **Last Dialed** ^[36]
If this mode is selected, pressing **Redial** will immediately repeat the most recent outgoing call in your call log. None of the other redial functions will be accessible.

You can [select the redial mode](#) ^[36] that the phone uses. In either case, the redial function uses the outgoing call records in your [personal call log](#) ^[68]. If you delete the records in your call log, redial will not work until new outgoing call records exist in your personal call log.

Note: Use of a centralized call log can be switched off by the system administrator. In that case the numbers used for the redial function are stored by the phone. This guide only covers redial using outgoing call records in the user's centralized call log.

4.1 Open Call Log Mode

This redial method is used when your phone's [redial mode](#) ^[36] is set to **List**.

1. Access the redial list.
 - a. Press **Redial**. The list of outgoing calls is displayed.
 - b. Use the ▲ up and down ▼ arrow keys to scroll through the 10 most recent outgoing calls.
2. Press **Call** to call the number displayed in the call record.
3. Continue in the same way as for a normal dialed call.

4.2 Last Dialed Mode

This redial method is used when your phone's [redial mode](#) ^[36] is set to **One**.

1. Press **Redial**.
2. The number for the most recent outgoing call in your personal call log is redialed.
3. Continue in the same way as for a normal dialed call.

4.3 Selecting Your Redial Mode

You can select whether your phone uses the redial list or last call redial mode.

1. Press the **Features** soft key if shown. To do this during a call, press the  **PHONE** key and then press the **Features** soft key.
2. Use the ▲ up and down ▼ arrow keys to highlight **Call Settings**. Press **Select**.
4. Use the ▲ up and down ▼ arrow keys to highlight **Redial Action**.
5. The current mode, **Open Call Log** or **Last Dialed** is displayed.
 - **Open Call Log** ^[36]
If this mode is selected, pressing **Redial** will display a menu of the most recent outgoing calls in your call log. You can select the call that you want to redial and perform a number of other functions.
 - **Last Dialed** ^[36]
If this mode is selected, pressing **Redial** will immediately repeat the most recent outgoing call in your call log. None of the other redial functions will be accessible.
6. Press **Change** to change the mode.
7. When the desired mode is displayed, press **Save**.

Chapter 5.

Holding and Parking Calls

5. Holding and Parking Calls

Holding a call and parking a call are two similar actions. The current caller is placed on hold and hears music if available. The table below summarizes the main differences between parking a call and holding a call.

When used to park or hold a call...	Hold	Park
... the call occupies an appearance button.	Yes	No
... the caller hears music on hold if available.	Yes	Yes
... the call can be retrieved by other users dialing a short code.	No	Yes
... the call recalls you automatically if your phone is idle.	Yes Default 15 seconds	Yes Default 5 minutes.
... can be used with conference calls.	Yes	No
... can be used to start or add calls to a conference.	Yes	No
... the call is assigned a unique ID.	No	Yes

5.1 Holding Calls

You can hold one or more calls.

- The held call will still occupy the appearance button on which it was made or answered.
- The caller will hear music on hold. If your system does not have music on hold available, the caller will hear double beep tones every few seconds.
- If you have more than one held call, or one held call and a connected call, pressing the **Conference** soft key will start a conference between yourself and the calls.

Calls that you have held will return to your phone (when idle) if they remain on hold for too long. The default return delay is 15 seconds. Your hold recall can be changed by the system administrator. Returning calls ignore any forwarding or do not disturb settings.

Important - Holding Conference Calls

You can hold a conference call in the same way as holding a normal call. Holding the conference call does not affect the other conference parties who can continue talking. You will also still be listed as a member of the conference call in the conference details.

Warning: This only applies to conference calls hosted by your own telephone system. Holding your call to a conference hosted on another telephone system may cause that conference to hear your system's music on hold.

5.1.1 Holding a Call

1. To put your current call on hold, press the **Hold** soft key or the call's appearance button.
2. The held call will be indicated by its call appearance button with a fast-flashing green lamp. On phones with only a single call appearance button (or icon), the phone displays "On-Hold" before the call information on the call's application line.
3. While held, the caller will hear music on hold. If your system does not have music on hold available, the caller will hear double beep tones every few seconds.
4. You can scroll the display using the ▲ up and down ▼ arrow keys. The held call will appear with a 📞 icon.

5.1.2 Taking a Call Off Hold

Either of the following methods can be used to retrieve a call from hold. If you have a currently connected call, that call will be automatically put on hold.

1. Press the appearance button with the fast-flashing red lamp call appearance.
2. Scroll the display using the ▲ up and down ▼ arrow keys, the held call will appear with a 📞 icon. Press the **Connect** soft key to take the call off hold.

5.1.3 Switching Between Calls

With a call on hold (fast-flashing appearance button) and another call connected (red call appearance button), you can switch between calls by pressing the appearance button of the held call. The current call is automatically put on hold and the previously held call is connected.

When you [place a call on hold](#)^[39] in order to [make a transfer](#)^[47], the call is considered 'on hold pending transfer' and is indicated by fast-flashing red *and* green appearance buttons. On phones with only a single appearance button (or icon), the phone displays "On-Hold-Xfer" before the call information on the call's application line.

5.1.4 Transferring a Held Call

There are various call transfer scenarios to consider:

1. If you have multiple calls on hold and you want to transfer a connected call to one of the held calls:
 - Press the **Transfer** soft key and use the ▲ up and down ▼ arrow keys to select the desired call appearance. When you are satisfied, press **Complete** to transfer the call while the other held call(s) remain on hold.
2. If you have calls on hold but you want to connect your current call with a new destination:
 - Press the **Transfer** soft key and enter the destination manually using the numerical keypad and press **Complete**. Alternatively, press **Dir** to [select a destination from the directory](#)^[64] or use the **Redial** option, if applicable.
3. If you have a destination call connected but you wish to refer back to the originating call before completing the transfer:
 - Do NOT press **Complete** to transfer the destination call as in scenario #2. Select the originating call ('on hold pending transfer') by pressing its call appearance button. This will place the destination call 'on hold pending transfer' so that you can notify the originating caller. With the originating call connected, you can now press **Complete** to connect the two calls. Held calls that are not pending transfer will not be affected. Moreover, it is not possible to have more than one call 'on hold pending transfer.'

Note: It is also possible to transfer a held call by [starting a conference](#)^[52] and then [dropping yourself](#)^[53] from that conference. However, if you are the only internal user in the conference, depending on your telephone system's configuration, dropping yourself might end the conference.

5.2 Parking Calls

Parking a call is similar to holding a call. However, parked calls can be unparked by other users on the phone system. Each parked call is given a number. By default, the number is your extension number plus a digit.

Calls that you park return to your phone (when idle) if they remain parked for too long. The default return delay is five minutes. This is a system delay that is applied to all users and can be changed by the system administrator. Returning calls ignore any forwarding or do not disturb settings.

A [feature button](#) ^[108] set to the **Call Park** action can be used to park and unpark calls and to indicate parked calls.

Default Short Codes

Short codes are numbers that you can dial to enable and disable various features. The following are default short codes that may be available. However, your system administrator can remove and change the short codes available to you or all users.

- **Park Call: *37*N#**
Parks the held call using the park number dialed in place of **N**.
- **Unpark Call: *38*N#**
Unpark the call parked using the park number **N**.

5.2.1 Parking Calls Using the Menu

1. Press the **Features** soft key if shown. To do this during a call, press the  **PHONE** key and then press the **Features** soft key.
2. Use the ▲ up and down ▼ arrow keys to highlight **Call Park** or **Call Park To Other**.
 - **Call Park**
Park the call on the system with parked call indication on your extension.
 - **Call Park To Other**
Park the call on the system with parked call indication on the selected extension.

Access Control

Your system administrator can configure whether you can access this menu option. See [Menu Access Control](#) ^[156].

5.2.2 Unparking Calls (Status Menu)

While parked calls are parked on the telephone system and can be unparked by any other user, the parked call indication is sent to a particular extension. If there are any calls parked against your phone, you can view and unpark them via the **Status** menu.

1. Press the **Status** soft key if shown.
 - To access the Status menu during a call, press the  **PHONE** key and then press the **Status** soft key if shown.
2. If you have any parked calls, the **Parks** option is displayed. The option is not present if you do not have calls parked against your extension.
3. Press the **Details** soft key.
4. Use the ▲ up and down ▼ arrow keys to scroll through the parked calls.
5. To unpark a particular call, press the **Connect** soft key.

Access Control

Your system administrator can configure whether you can access this menu option. See [Menu Access Control](#) ^[156].

5.2.3 Park & Page

This method of parking calls is available only if specifically configured on your telephone system. To use it, you also need to add a **Park & Page** button on your phone. See [Button Features](#)^[108].

Park and page uses a set of park slot numbers, configured by your system administrator, that act like extension numbers. When you parked a call in one of those park slots, you or any other user on the system can dial that park slot number to unpark the call.

Your system administrator can also configure up to 3 hunt groups for paging. When you park a call, after displaying the park slot number used, your phone displays options for paging.

Calls parked using Park & Page are not indicated in your phone's **Status** menu. However, calls that you park will recall to your phone if left parked for too long.

If your phone has any **Call Park** buttons set to match the park slot numbers configured for Park & Page, those buttons can be used to park/unpark calls and indicate when a call is parked in that park slot. However, when used to park a call, the phones does not display the page options.

To Park a Call Using Park & Page

1. Press the **Park & Page** button on your phone. The call is parked and the parked slot number needed to unpark the call is displayed.
2. If you want to make a page announcement of the parked call, press **Page**. Otherwise, press **Exit**.
3. There are several methods by which you can select the user or hunt group that you want to page:
 1. Select one of the pre-configured hunt groups and press **Page**.
 2. Press **Dir**. Select the required user or hunt group from the directory and press **Page**.
 3. Dial the extension number of the user or hunt group that you want to page and then press **Page**.

To Unpark a Call

1. Dial the park slot number that was assigned to the parked call.

Chapter 6.

Transferring Calls

6. Transferring Calls

You are able to transfer calls even if all your current call appearance buttons are in use.

1. Press **Transfer**. The current call is automatically put on hold pending transfer.
2. Dial the number for the transfer. Alternatively, press **Dir** to [select a destination from the directory](#) ^[64] or use the **Redial** option, if applicable.
 - To complete the transfer, press **Complete**. You can do this while the call is still ringing.
 - Transferring a call while it is still ringing is called an unsupervised transfer.
 - Transferring a call after ringing finishes is called a supervised transfer.
 - If the transfer destination does not answer or, after answering the call, does not want to accept the call, press the **Cancel** soft key.
3. Press **Complete** to complete the transfer. If the transfer destination does not answer or does not want to accept the call, press the **Cancel** soft key.

Notes

- **Calls and Button Status Indication**

The status indication for a call on hold pending transfer differs from that used for standard held calls:

- On phones with dual lamp buttons, both the green and red lamps fast flash (flutter) when the button represents a call on hold pending transfer.
- On phones with single lamp buttons or status icons, **Xfer:** is shown in front of the caller ID information rather than the button name. For example **Xfer:Extn299** is shown rather than **a = Extn299**.
- The call status information shown when a call on hold pending transfer is highlight is prefixed with **On-Hold-Xfer** rather than **On-Hold**.

- **Switching Between Calls**

Switching from a connected call to an existing call on hold pending transfer puts the connected call on hold pending transfer.

6.1 Transferring to Voicemail

When set to visual voice mode, the  key can be used to transfer your current call to the voicemail mailbox of another user or group.

1. With the call connected, press the  key. You are still connected to the call and can continue talking.
2. Dial the extension number of the user or group to which you want to transfer the call.
3. When the number matches a user or group, their name is displayed.
 - To transfer the call to the user or group's mailbox, press **Select**. The caller will hear a few seconds of ringing and then the mailbox greeting.
 - To exit the transfer menu, press **Cancel**.

6.2 Transferring a Held Call

There are various call transfer scenarios to consider:

1. If you have multiple calls on hold and you want to transfer a connected call to one of the held calls:
 - Press the **Transfer** soft key and use the ▲ up and down ▼ arrow keys to select the desired call appearance. When you are satisfied, press **Complete** to transfer the call while the other held call(s) remain on hold.
2. If you have calls on hold but you want to connect your current call with a new destination:
 - Press the **Transfer** soft key and enter the destination manually using the numerical keypad and press **Complete**. Alternatively, press **Dir** to [select a destination from the directory](#)^[64] or use the **Redial** option, if applicable.
3. If you have a destination call connected but you wish to refer back to the originating call before completing the transfer:
 - Do NOT press **Complete** to transfer the destination call as in scenario #2. Select the originating call ('on hold pending transfer') by pressing its call appearance button. This will place the destination call 'on hold pending transfer' so that you can notify the originating caller. With the originating call connected, you can now press **Complete** to connect the two calls. Held calls that are not pending transfer will not be affected. Moreover, it is not possible to have more than one call 'on hold pending transfer.'

Note: It is also possible to transfer a held call by [starting a conference](#)^[52] and then [dropping yourself](#)^[53] from that conference. However, if you are the only internal user in the conference, depending on your telephone system's configuration, dropping yourself might end the conference.

6.3 Transferring a Call to Your Mobile

If you have been configured as a mobile twinning user, you can transfer a call to your mobile device using the features menu.

1. Press the **Features** soft key if shown. To do this during a call, press the  **PHONE** key and then press the **Features** soft key.
2. If necessary, use the ▲ up and down ▼ arrow keys to highlight **Transfer to Mobile**. Press **Select**.

Access Control

Your system administrator can configure whether you can access this menu option. See [Menu Access Control](#)^[156].

Chapter 7.

Account Codes

7. Account Codes

The telephone system can store a number of account codes. Account codes may be used to keep track of calls in relation to particular activities or clients. They can also be used to keep track of calls by particular users or sets of users.

- When an account code is entered while making a call or during a call, that account code is included in the call records output by the system.
- Accounts entered are checked against those stored by the telephone system. If an invalid code is entered, the account code is requested again.
- The system administrator can configure certain numbers or types of numbers to require entry of an account code before you can continue making a call to such a number.
- The system administrator can also configure a requirement for you to enter an account code before making any external call.

7.1 Forced Account Code Entry

The system administrator can configure certain numbers or types of numbers to require entry of an account code before you can continue making a call to such a number.

1. The **Account Code** menu is displayed when you are required to enter an account code.
2. Enter the account code that you want to use.
3. Press the **Done** soft key.
4. If the account code was not a valid account code, the **REENTER ACCOUNT** menu is displayed.

7.2 Manual Account Code Entry

You can enter account codes during a call or before making a call. The account code that you enter must match an account code set on the telephone system.

1. Press the **Features** soft key if shown. To do this during a call, press the  **PHONE** key and then press the **Features** soft key.
2. Use the ▲ up and down ▼ arrow keys to highlight **Call Settings**. Press **Select**.
4. Use the ▲ up and down ▼ arrow keys to highlight **Account Code**.
5. Press the **Set** soft key or the **OK** button or the ► right arrow key.
6. Enter the account code that you want to use.
7. Press the **Done** soft key.
8. If the account code was not a valid account code, the **Failed** menu is displayed.

Access Control

Your system administrator can configure whether you can access this menu option. See [Menu Access Control](#) ¹⁵⁶.

Feature Button

Access to the enter account code menu can be assigned to a [feature button](#) ¹⁰⁸ configured with the Account Code Entry action. The button can also be preset with a specific account code.

Chapter 8.

Conference Calls

8. Conference Calls

The telephone system supports multiple conference calls, with additional parties addable to any conference call until the system's conference capacity is reached. A maximum of 64 parties in any particular conference call is supported. Conference resources are also used for call recording and other features, reducing the available conference capacity for ordinary conference calls.

Some conference controls, for example dropping other parties, only apply to conferences started on the same phone system as your extension.

Note: If you are the only internal user in the conference, depending on your telephone system's configuration, dropping yourself might end the conference. Consult your system administrator for details.

Default Short Codes

Short codes are numbers that you can dial to enable and disable various features. The following are default short codes that may be available. However, your system administrator can remove and change the short codes available to you or all users.

- **Conference Held Calls: *47**
Start a conference between yourself and any calls that you have on hold.

8.1 Starting a Conference

If you do not already have a held call, you can use the process below to start a conference. For more complex scenarios see [Context Sensitive Conferencing](#) ^[54].

1. Make a call to the first party or answer a call.
2. Press the **Conf** soft key. The current call is automatically put on hold.
3. Dial the party that you want to add to the conference.
4. If they answer and want to join the call, press **Conf** again.
5. If they do not want to join the call or do not answer, press **Drop** and then press the appearance key of the held call.

8.2 Adding a Call to a Conference

You can add parties to an existing conference.

1. Press **HOLD** to put the conference on hold. This does not affect the other conference parties who can continue talking to each other.
2. Press an available appearance key on which to make a call.
3. Dial the party that you want to add to the conference.
4. If they answer and want to join the call, press **Conf** again.
5. If they do not want to join the call or do not answer, press **Drop** and then press the appearance key of the held call.

8.3 Viewing Conference Details

You can display a list of the parties involved in a conference call.

1. If not already displayed, press the ▲ up or down ▼ arrow key to display the conference call.
2. Press the **Details** soft key.
 - To scroll through the list of callers in the conference, use the ▲ up and down ▼ arrow keys.
 - To drop a caller from the conference, highlight them and press **Drop**.
 - To mute a caller, highlight them and press **Mute**. Repeat this to unmute them.
 - To return to the call display, press the **Back** soft key.

8.4 Dropping/Muting Parties

You can drop parties from a conference call, including yourself. You can also mute other parties.

1. While connected to a conference call, if you press the **Details** key, the conference details menu is displayed.
2. You can then perform the following actions:
 - To scroll through the list of callers in the conference, use the ▲ up and down ▼ arrow keys.
 - To drop a caller from the conference, highlight them and press **Drop**.
 - To mute a caller, highlight them and press **Mute**. Repeat this to unmute them.
 - To return to the call display, press the **Back** soft key.

Note: If you are the only internal user in the conference, depending on your telephone system's configuration, dropping yourself might end the conference. Consult your system administrator for details.

8.5 Holding a Conference Call

Using the **Hold** soft key you can put a conference call on hold in the same way as you can for a normal call. The appearance key for the conference call will show a fast-flashing red lamp.

To take the conference call off hold, press the appearance key.

Important - Holding Conference Calls

You can hold a conference call in the same way as holding a normal call. Holding the conference call does not affect the other conference parties who can continue talking. You will also still be listed as a member of the conference call in the conference details.

Warning: This only applies to conference calls hosted by your own telephone system. Holding your call to a conference hosted on another telephone system may cause that conference to hear your system's music on hold.

8.6 Context Sensitive Conferencing

The scenarios for [starting a conference](#)^[52] and [adding a call to a conference](#)^[52] cover just simple scenarios where no other calls are in progress. The phone supports a range of context sensitive scenarios to control which calls are added to the conference

For this phone, which calls are conferenced when **Conf** or **Conference** is pressed depends on which call is currently highlighted on the phone's display and the types of other held calls.

Highlighted Call	Other conditions in priority order	Result when Conf or Conference is pressed:	Calls Conferenced		
			Current Call	Held Calls	Held Pending Transfer
Connected call	No call held pending transfer	Conferences the connected call and all held calls.	Yes	Yes	-
	Call held pending transfer	Conferences the connected call and the held pending transfer call. Any other held calls are unaffected.	Yes	-	Yes
Held call	Connected call	Conferences the held call and the connected call. Any other held calls including held pending transfer are unaffected.	Yes	-	-
	Held pending transfer call	Conferences the held and held pending transfer call. All other held calls are unaffected.	-	-	Yes
	Held calls	Conferences with all other held calls.	-	Yes	-
Held pending transfer call	Connected call	Conferences the held pending transfer call to a connected call. Any other held calls are unaffected.	Yes	-	Yes
	Held calls	Conferences the call held pending transfer with all other held calls.	-	Yes	Yes

Note, the above only applies to conferences initiated from the telephone. The traditional behaviour of conference all current and held calls regardless of type still applies if the conference is initiated from elsewhere such as from an application like one-X Portal for IP Office.

- **Changing which call is currently highlighted**

On phones with a set of cursor keys, the up and down cursor keys can be used to select the current highlighted call appearance, even while there is a currently connected call. On touchscreen phones, the cursor buttons on the right-hand edge of the screen can be used for the same purpose.

- On most phones in the series, the background shading indicates the currently highlighted call. The exception is 9611, 9621 and 9641 telephones where a yellow symbol is shown on the right of the currently selected call.

Chapter 9.

Headset/Handsfree Operation

9. Headset/Handsfree Operation

9.1 Headset Operation

Your phone has a headset socket located under the phone. This is suitable for the connection of phone headsets that connect via a HIS headset cable.

- If there are no currently connected call to which you are talking, a call answered by pressing its appearance button is connected either handsfree or through the headset according to the phone's [audio path setting](#)^[57].
- If there is already a connected call to which you are talking through the headset, answering another call by pressing the appearance button will answer that call using the headset.

Using a Headset

To answer a call using a headset:

1. To answer a call using the headset, press the  **HEADSET** button. The button remains lit whilst you have a call connected on the headset.

To end a headset call:

1. To end a headset call, press the  **HEADSET** button.

To switch from the headset to the handset:

1. To switch from the headset to the handset, simply lift the handset.

To switch to handsfree from the headset:

1. To switch to handsfree from the headset, press the  **HEADSET** button. The button remains lit whilst you have a call connected on the headset.
2. Replace the handset.

To switch from the headset to handsfree:

1. Press the  **SPEAKER** button. See [Handfree Speaker Operation](#)^[59].

To switch to headset from handsfree:

1. Press the  **HEADSET** button. The button remains lit whilst you have a call connected handsfree.

To mute the call while on the headset:

1. Press the  **MUTE** button. The button remains lit whilst the call is muted. Note that if you switch to the handset or handsfree, the mute is automatically canceled.

Headset Operation Settings

You can adjust the following headset settings:

- [Headset Volume](#)^[57]
- [Default Audio Path](#)^[57]
- [Headset Automatic Gain Control On/Off](#)^[57]

9.1.1 Headset Volume







While talking via the headset, you can adjust the volume of the incoming call. The status indication line displays a  icon followed by eight bubbles that represent the volume level.

1. With the call connected on the headset, press the  key.
2. Use the **+** plus and **-** minus keys to adjust the volume.
3. The display returns to normal after a few seconds.

9.1.2 Default Handsfree Audio Path







By default, when you make a call or answer a call without lifting the handset, the audio is played through the phone's speaker while you speak via the phone's microphone.

If you have a headset attached, you can change the phone's behavior so that the audio is played through the headset by default rather than the speaker.

1. Press the  **MENU/HOME** button and select **Settings**.
2. Use the  up and down  arrow keys to highlight **Options & Settings**. Press **Select**.
3. Use the  up and down  arrow keys to highlight **Call Settings**. Press **Select**.
4. Use the  up and down  arrow keys to highlight **Audio Path**.
5. Press **Change** to change the setting between **Headset** and **Speaker**.
6. When completed, press the **Save** soft key.
7. Press the **Back / Exit** soft keys to exit the menus.

9.1.3 Automatic Gain Control

When using automatic gain control (AGC), the phone tries to maintain a constant audio level even if the incoming call changes between loud and quiet.

1. Press the  **MENU/HOME** button and select **Settings**.
2. Use the  up and down  arrow keys to highlight **Advanced Options**. Press **Select**.
3. Use the  up and down  arrow keys to highlight **Automatic Gain Control**. Press **Select**.
 - Use the  up and down  arrow keys to switch between **Handset**, **Headset**, or **Speaker** settings for AGC.
 - To change the highlighted setting, press **Change**.
4. When completed, press **Save**.
5. Press **Back / Exit** to exit the menus.

9.1.4 Using Bluetooth Headsets

The 9641 telephone can support a Bluetooth headset (if allowed by your system administrator).

To enable Bluetooth support:

1. Press the **A HOME** button and select **Settings**.
2. If **Bluetooth Settings** is shown in the menu then Bluetooth is already supported on the phone.
3. Select **Options & Settings** and then **Advanced Options**.
4. Select **Enable Bluetooth** to change its current setting.
5. Click **Save**.

To pair the phone with a Bluetooth headset:

1. Put the headset into pairing mode using the headset manufacturer's instructions. .
2. Press the **A HOME** button and select **Settings**.
2. Select **Bluetooth Settings**.
3. Click on **Scan**.
4. When the headset is detected, its name appears in the list of paired devices.

To connected a paired headset:

1. Put the headset into pairing mode using the headset manufacturer's instructions. .
2. Press the **A HOME** button and select **Settings**.
3. Select **Bluetooth Settings**.
4. Click on the headset name in the list of paired devices.
5. Click **Connect**.

9.1.5 Headset Alert Sounds

When using a headset, the phone can provide additional audio alerts through that headset, These alerts are in addition to the phone's normal visual alerting and ringer.

The phone can provide headset alerts when it goes off and on hook. It can also provide a headset alert when calls are waiting to be answered. That includes calls waiting to be answered when you already have a call connected.

Enabling Headset Alerts

1. Press the **A MENU/HOME** button and select **Settings**.
2. Use the **▲** up and down **▼** arrow keys to highlight **Options & Settings**. Press **Select**.
3. Use the **▲** up and down **▼** arrow keys to highlight **Call Settings**. Press **Select**.
4. Select **Headset Signalling**.
5. Select the headset alerting mode required:
 - **None**
The phone does not provide any additional alert sounds through the headset.
 - **Switchhook only**
The phone provides alerts sounds when the phone goes off-hook (a single click) or back on-hook (a double click).
 - **Switchhook & Alerting**
The phone provides alerts as above plus an additional alert (three clicks) whenever a call is waiting to be answered.
6. Depending on the phone, pressing either **Save** or **Select**.

9.2 Handsfree Speaker Operation

Your phone has a speaker and microphone that allows you make and answer calls handsfree. The speaker is located under the handset. The microphone is located near the bottom right of the phone's keypad.

- If there are no currently connected calls to which you are talking, a call answered by pressing its appearance button is connected either handsfree or through the headset according to the phone's [audio path setting](#) ^[57].
- If there is already a connected call to which you are talking handsfree, answering another call by pressing the appearance button answers that call handsfree.

Conference Phones

Your phone is not designed as a conference room speakerphone. It is designed for use by a speaker located directly in front of the phone with no obstructions between themselves and the microphone. Phones designed to be used as conference speakerphones typically have multiple microphones and are able to handle sounds coming from multiple directions. For details of conference speakerphones supported by your phone system contact your system administrator.

Using Handsfree

To answer a call handsfree:

1. To answer a call handsfree, press the **|| SPEAKER** button. The button remains lit whilst you have a call connected handsfree.

To end a handsfree call:

1. To end a handsfree call, press the **|| SPEAKER** button.

To switch from handsfree to the handset:

1. To switch from handsfree to the handset, simply lift the handset.

To switch to handsfree from the handset:

1. To switch to handsfree from the handset, press the **|| SPEAKER** button. The button remains lit whilst you have a call connected handsfree.
2. Replace the handset.

To switch from handsfree to the headset:

1. Press the **HEADSET** button. See [Headset Operation](#) ^[59].

To switch to handsfree from the headset:

1. Press the **|| SPEAKER** button. The button remains lit whilst you have a call connected handsfree.

To mute the call while handsfree:

1. Press the **MUTE** button. The button remains lit whilst the call is muted. Note that if you switch to the handset or headset, the mute is automatically canceled.

Handsfree Operation Settings

You can adjust the following handsfree settings:

- [Speaker Volume](#) ^[60]
- [Default Audio Path](#) ^[60]
- [Speaker Automatic Gain Control On/Off](#) ^[60]

9.2.1 Speaker Volume







While talking handsfree via the phone's speaker, you can adjust the volume of the incoming call. The status indication line will display a  icon followed by eight bubbles that represent the volume level.

1. With the call connected on the speaker, press the  key.
2. Use the **+** plus and **-** minus keys to adjust the volume.
3. The display returns to normal after a few seconds.

9.2.2 Default Handsfree Audio Path







By default, when you make a call or answer a call without lifting the handset, the audio is played through the phone's speaker while you speak via the phone's microphone.

If you have a headset attached, you can change the phone's behavior so that the audio is played through the headset by default rather than the speaker.

1. Press the **A MENU/HOME** button and select **Settings**.
2. Use the  up and down  arrow keys to highlight **Options & Settings**. Press **Select**.
3. Use the  up and down  arrow keys to highlight **Call Settings**. Press **Select**.
4. Use the  up and down  arrow keys to highlight **Audio Path**.
5. Press **Change** to change the setting between **Headset** and **Speaker**.
6. When completed, press the **Save** soft key.
7. Press the **Back / Exit** soft keys to exit the menus.

9.2.3 Automatic Gain Control

When using automatic gain control (AGC), the phone tries to maintain a constant audio level even if the incoming call changes between loud and quiet.

1. Press the **A MENU/HOME** button and select **Settings**.
2. Use the  up and down  arrow keys to highlight **Advanced Options**. Press **Select**.
3. Use the  up and down  arrow keys to highlight **Automatic Gain Control**. Press **Select**.
 - Use the  up and down  arrow keys to switch between **Handset**, **Headset**, or **Speaker** settings for AGC.
 - To change the highlighted setting, press **Change**.
4. When completed, press **Save**.
5. Press **Back / Exit** to exit the menus.

Chapter 10.

Contacts/Directory

10. Contacts/Directory

This menu is accessed by pressing the  **CONTACTS** key. It is used to display names and numbers that you can then use for making calls.

The directory includes names stored for use by all users, names stored for use by just you and the name and numbers of all the other users and groups on the phone system.

The contacts shown in the directory come from a number of sources.

- **Personal Directory Contacts**

These contacts are stored by the telephone system as part of your user settings.

- They are displayed on the phone while you are using it. If you hot desk to another phone that also stores your contacts on the system, your personal contacts move with you.
- You can have up to 100 personal directory entries^[2] that you can add, edit and delete through the phone.
Note: While each user is allowed up to 100 personal directory entries, the total capacity of the system may limit the addition of further personal directory entries for all users.
- The system administrator can add, edit and delete your personal directory entries.
- The system administrator can also set users and hunt groups as **Ex Directory**. Those users and hunt groups are then not included in the directory.

- **User Contacts**

These contacts list all^[3] the other users on the telephone system. If your system is part of a network of telephone systems, it includes users on the other systems.

- **Group Contacts**

These contacts list all the hunt groups on the telephone system. If your system is part of a network of telephone systems, it includes those hunt groups that the system administrator has configured to be advertised across the network.

- **External Contacts**

These contacts are viewable and useable by all phone users. These are two types of external contacts:

- Some external contacts are entered into the telephone system configuration by the system administrator.^[1]
- Other external contacts are those imported by the telephone system from other directory sources.

Note: If you have been configured as a system phone user by the system administrator, then you can also add, edit and delete some external directory contacts.

10.1 Managing External Contacts



If you have been configured as a system phone user by the system administrator, then you can also add, edit and delete some external directory contacts.

- This only applies to external directory contacts entered locally into configuration of the telephone system to which you are logged in.
- External directory contacts imported by the system from other sources cannot be edited. However, if a local entry is created with the same name or number as an imported entry, the imported entry is discarded in favour of the local one.



10.2 Viewing Contacts Details

1. Access the contacts directory:

a. Press the  **CONTACTS** key. The directory menu is displayed.

b. Use the  left and right  arrow keys to select which type of directory entries you want to display.

- **All**
All directory entries.
- **External**
Directory entries stored by the telephone system for all users to use.
- **Groups**
The names and numbers of hunt groups on the telephone system.
- **Users**
The names and numbers of other users on the telephone system.
- **Personal**
Your own personal directory entries.

c. Use the  up and down  arrow keys to scroll through the list. Alternatively you can start dialing the name you want to find to display only matching entries as follows:

- Pressing a button enters all of the characters represented by that button. Pressing another button adds the characters from that button as the next possible characters. For example, dialing **527** simultaneously match all names starting with **JAS** (for example "Jason") and with **KAR** (for example "Karl") plus any other letter combinations from those buttons.
- The characters represented by each dialing pad button depend on the language used by your telephone system. See [Entering Characters](#) ^[158].
- To remove all the characters entered so far press **Clear**.

d. To view more details of the highlighted name, press **Details**. To return to the directory press **List**.

2. When the required entry is highlighted, press **Details** to display the name, number and type of contact.

3. Use the  up and down  arrow key to scroll through the contacts.

4. The range of soft keys available will depend on the type of directory entry:

- **Call** ^[64]
Make a call to the stored number.
- **List**
Return to the list of contacts.
- **More**
If the contact is one of your personal directory entries, the **More** soft key will be present to allow you to access the options below. It is also present for external directory entries if you have been set as a system phone user by the system administrator.
- **Edit** ^[66]
Edit the name and number.
- **Delete** ^[66]
Delete the name and number.
- **New** ^[65]
Add a new personal directory contact.

10.3 Making a Call from the Directory

You can use any directory contact to make a call. You can also use the directory in almost any telephone function where you need to select the number for a destination, for example during a transfer.

1. Access the contacts directory:

a. Press the  **CONTACTS** key. The directory menu is displayed.

b. Use the ◀ left and right ▶ arrow keys to select which type of directory entries you want to display.

- **All**
All directory entries.
- **External**
Directory entries stored by the telephone system for all users to use.
- **Groups**
The names and numbers of hunt groups on the telephone system.
- **Users**
The names and numbers of other users on the telephone system.
- **Personal**
Your own personal directory entries.

c. Use the ▲ up and down ▼ arrow keys to scroll through the list. Alternatively you can start dialing the name you want to find to display only matching entries as follows:

- Pressing a button enters all of the characters represented by that button. Pressing another button adds the characters from that button as the next possible characters. For example, dialing **527** simultaneously match all names starting with **JAS** (for example "Jason") and with **KAR** (for example "Karl") plus any other letter combinations from those buttons.
- The characters represented by each dialing pad button depend on the language used by your telephone system. See [Entering Characters](#) ^[158].
- To remove all the characters entered so far press **Clear**.

d. To view more details of the highlighted name, press **Details**. To return to the directory press **List**.

2. When the required entry is highlighted, press **Call** or press the  button next to the name.

3. Proceed as you would with a normally dialed call.

10.4 Using the Directory for Other Functions

Within other menus where entry of a number is required, it may be possible to use the directory to select an existing number by name. If this option is available, it will be indicated by the presence of a **Dir** soft key in the menu.

When using the directory in this way, the names made available will depend on the type of function that is being set. For example, for some functions only group names will be displayed, for others only user names.

1. Press the **Dir** soft key.

2. Either dial the name to see a list of matches or press the **List** soft key to list all names.

a. Use the ▲ up and down ▼ arrow keys to scroll through the list or start dialing the name you want to find to display only matching entries. If you dial a name to return to the full list press the **Clear** soft key.





b. To view more details of the highlighted name press **Details**. To return to the directory press **List**.

3. When the required entry is highlighted, press **Select**.

4. You will be returned to the menu in which you selected the **Dir** soft key.

10.5 Adding a New Contact











So long as the telephone system capacity has not been reached, you can add up to 100 personal directory entries.

1. Access your personal directory contacts:
 - a. Press the  **CONTACTS** key. The directory menu is displayed.
 - b. Use the  left and right  arrow keys to select your **Personal** directory.
2. Press the **New** soft key.
 - The menu now allows editing of the name and number. See [Entering Characters](#) ^[158].
 - Use the  up and down  arrow keys to switch between number and name entry.
 - When the name and number have been entered as required, press the **Save** soft key.
 - To exit without making any changes, press the **Cancel** soft key.

Note: If you have been configured as a system phone user by the system administrator, then you can also add, edit and delete some external directory contacts.







10.6 Adding a Contact from the Call Log/History

You can add a name and number shown in your call log to your personal contacts.

1. Access the call log.
 - a. Press the  **HISTORY** button.
 - b. The display will change to show your call log records. The caller's name is shown if known, otherwise the number. If you have any new missed call records, the button is illuminated and the call log will open showing your missed calls.
 - c. Use the  left and right  arrow keys to select which call log records you are viewing. The options are **All**, **Outgoing** , **Incoming**  and **Missed** . On touch screen phones, press the icon for the type of call log records you want to display.
 - d. Use the  up and down  arrow keys to scroll through the records.
2. Press **More** and then press the **+Contact** soft key.
3. Use the  up and down  arrow keys to switch between the name and number details for the new contact.
4. Using the telephone keypad and the **Bksp** soft key you can edit the name and the number. See [Entering Characters](#) ^[158]. When editing the number, use the **Pause** soft key to enter a comma (,) for a 1 second pause in the number dialing.
5. When the name and number are set as required, press the **Save** soft key. To return without saving the name and number, press the **Cancel** soft key.

10.7 Editing a Contact





You can edit the contacts in your own personal directory.

1. Access your personal directory contacts:
 - a. Press the  **CONTACTS** key. The directory menu is displayed.
 - b. Use the  left and right  arrow keys to select your **Personal** directory.
 - c. Use the  up and down  arrow keys to scroll through the list. Alternatively you can start dialing the name you want to find to display only matching entries as follows:
 - Pressing a button enters all of the characters represented by that button. Pressing another button adds the characters from that button as the next possible characters. For example, dialing **527** simultaneously match all names starting with **JAS** (for example "Jason") and with **KAR** (for example "Karl") plus any other letter combinations from those buttons.
 - The characters represented by each dialing pad button depend on the language used by your telephone system. See [Entering Characters](#) ^[158].
 - To remove all the characters entered so far press **Clear**.
 - d. To view more details of the highlighted name, press **Details**. To return to the directory press **List**.
2. Locate the required entry.
3. Press the **Details** soft key.
4. Press the **More** soft key and then the **Edit** soft key.
 - The menu now allows editing of the name and number. See [Entering Characters](#) ^[158].
 - Use the  up and down  arrow keys to switch between number and name entry.
 - When the name and number have been entered as required, press the **Save** soft key.
 - To exit without making any changes, press the **Cancel** soft key.

Note: If you have been configured as a system phone user by the system administrator, then you can also add, edit and delete some external directory contacts.

10.8 Deleting a Contact

You can delete a contact from your own personal directory.

1. Access your personal directory contacts:
 - a. Press the  **CONTACTS** key. The directory menu is displayed.
 - b. Use the  left and right  arrow keys to select your **Personal** directory.
 - c. Use the  up and down  arrow keys to scroll through the list. Alternatively you can start dialing the name you want to find to display only matching entries as follows:
 - Pressing a button enters all of the characters represented by that button. Pressing another button adds the characters from that button as the next possible characters. For example, dialing **527** simultaneously match all names starting with **JAS** (for example "Jason") and with **KAR** (for example "Karl") plus any other letter combinations from those buttons.
 - The characters represented by each dialing pad button depend on the language used by your telephone system. See [Entering Characters](#) ^[158].
 - To remove all the characters entered so far press **Clear**.
 - d. To view more details of the highlighted name, press **Details**. To return to the directory press **List**.
2. Locate the required entry.
3. Press the **Details** soft key.
4. Press the **More** soft key and then the **Delete** soft key.
5. Press the **Delete** soft key again to confirm the action.

Note: If you have been configured as a system phone user by the system administrator, then you can also add, edit and delete some external directory contacts.

Chapter 11.

Call History

11. Call History

This menu is accessed by pressing the  **HISTORY** key. The call log you see is a call log stored on the telephone system. If you log in at another phone that also stores a call log, your call history moves with you.

Your call history contains your most recent answered calls, the most recent calls you made and the most recent missed calls. If configured by the system administrator, it can also include the most recent calls missed by each hunt group of which you are a member.

- [Making a Call](#) 
- [Viewing Call Details](#) 
- [Deleting a Record](#) 
- [Deleting All Records](#) 
- [Add a Record to Your Contacts](#) 

Missed Calls

Missed calls are calls to you that you did not answer. Your system administrator can also configure whether or not the log includes calls presented to you but are answered by someone else or by voicemail.

The  **History** button is illuminated when you have any new missed calls in your call log. The lamp is extinguished when you have viewed the missed call in the call log or the record of that call is no longer in your call log.

The  icon is also used at the top left of the phone display to indicate missed calls and is prefixed with the number of missed calls.





Missed Group Call

If you are a member of any hunt groups, the system administrator can configure whether your missed calls log should also include missed hunt groups calls. The hunt group does not necessarily have to have rung at your phone. It will be recorded as missed if it was presented to the hunt group and not answered by any of the members including you.



Notes

1. Centralized call log can be turned off by the [system administrator](#) . In that case the call log is stored by the phone and is lost if the phone is reset. This guide only covers the centralized call log stored by the telephone system.
2. The call log on other types of phones is a local call log maintained by that phone. It will not move with you when you hot desk and it will be lost if the phone is restarted.
3. The redial function uses the outgoing call records stored in the call log.

11.1 Accessing the Call Log/History

1. Access the call log.
 - a. Press the  **HISTORY** button.
 - b. The display will change to show your call log records. The caller's name is shown if known, otherwise the number. If you have any new missed call records, the button is illuminated and the call log will open showing your missed calls.
 - c. Use the ◀ left and right ▶ arrow keys to select which call log records you are viewing. The options are **All**, **Outgoing** , **Incoming**  and **Missed** . On touch screen phones, press the icon for the type of call log records you want to display.
 - d. Use the ▲ up and down ▼ arrow keys to scroll through the records.
2. Pressing **OK** will make a call to the number stored with the currently displayed record.
3. You can use the functions listed at the bottom of the display by pressing the soft key below the function name.
 - **Call** 

Make a call to the number stored in the currently displayed call log record.
 - **Details** 

Display more details about the current call log record. You can also [add the caller details to your personal directory](#)  if required.
 - **Delete** 

Deletes the currently displayed record.
 - **More**





Switch between the different sets of available soft key functions.
 - **Del All** 

Delete all the call log records, not just the current types of records being shown.
 - **+Contact** 

Add the currently highlighted call log record to your personal contacts.
4. To exit the call log, press the **PHONE/EXIT** button.

11.2 Making a Call









You can use the call log to make calls to the number included in the currently selected call record.

1. Access the call log.
 - a. Press the  **HISTORY** button.
 - b. The display will change to show your call log records. The caller's name is shown if known, otherwise the number. If you have any new missed call records, the button is illuminated and the call log will open showing your missed calls.
 - c. Use the ◀ left and right ▶ arrow keys to select which call log records you are viewing. The options are **All**, **Outgoing** , **Incoming**  and **Missed** . On touch screen phones, press the icon for the type of call log records you want to display.
 - d. Use the ▲ up and down ▼ arrow keys to scroll through the records.
2. Press **Call** to call the number displayed in the call record.



11.3 Viewing Call Details

You can view additional details about the currently shown call.



1. Access the call log.

- a. Press the  **HISTORY** button.
- b. The display will change to show your call log records. The caller's name is shown if known, otherwise the number. If you have any new missed call records, the button is illuminated and the call log will open showing your missed calls.
- c. Use the  left and right  arrow keys to select which call log records you are viewing. The options are **All**, **Outgoing** , **Incoming**  and **Missed** . On touch screen phones, press the icon for the type of call log records you want to display.
- d. Use the  up and down  arrow keys to scroll through the records.

2. Press the **Details** soft key. The individual details of the currently selected call record are displayed. The possible values are:





- **Name** - The name of the caller if known.
- **Number** - The number of the caller if available.
- **Time and Date** - The time of the call.
- **Call Type Icon** - The type of call record, ie.  = **Incoming**,  = **Outgoing** or  = **Missed**.
- **Count** - How many time a call of the same type, name and number has occurred. Only the details of the most recent call are kept in your call log. However the count indicates if the caller has rung or has been rung several times.
- **Duration** - The length of the call.

4. While you are in the details of a call record, the soft key functions available are:

- **Call**
Call the number shown in the call record. You can also do this by pressing the **OK** button.
- **List**
Go back to the normal call screen to select another call record. You can also use the  up and down  arrow keys to view the previous or next record.
- **Delete**
Delete the currently displayed record.
- **More**
Switch between the different sets of available soft key functions.
- **+Contact**
Add the name and number to your personal directory. You can edit the details before they are added.
- **Delete All**
Delete all the records.





11.4 Deleting a Record

You can delete the currently displayed call record. If the record is a missed hunt group call, the record is also deleted from the call log of other users configured to see the same hunt group's missed calls.

1. Access the call log.
 - a. Press the  **HISTORY** button.
 - b. The display will change to show your call log records. The caller's name is shown if known, otherwise the number. If you have any new missed call records, the button is illuminated and the call log will open showing your missed calls.
 - c. Use the ◀ left and right ▶ arrow keys to select which call log records you are viewing. The options are **All**, **Outgoing** , **Incoming**  and **Missed** . On touch screen phones, press the icon for the type of call log records you want to display.
 - d. Use the ▲ up and down ▼ arrow keys to scroll through the records.
2. When the required record is highlight, press **More** and then press **Delete**.





11.5 Deleting All Records

You can delete all call records from your call log. This action deletes all call log record types (**Incoming**, **Missed** and **Outgoing**), not just the type you are currently viewing. This action deletes your personal call records and any hunt group call records.

1. Access the call log.
 - a. Press the  **HISTORY** button.
 - b. The display will change to show your call log records. The caller's name is shown if known, otherwise the number. If you have any new missed call records, the button is illuminated and the call log will open showing your missed calls.
 - c. Use the ◀ left and right ▶ arrow keys to select which call log records you are viewing. The options are **All**, **Outgoing** , **Incoming**  and **Missed** . On touch screen phones, press the icon for the type of call log records you want to display.
 - d. Use the ▲ up and down ▼ arrow keys to scroll through the records.
2. Press the **More** soft key.
3. Press the **Del All** soft key to delete all your call log records.

11.6 Adding a Record to Your Contacts

You can add a name and number shown in your call log to your personal contacts.

1. Access the call log.
 - a. Press the  **HISTORY** button.
 - b. The display will change to show your call log records. The caller's name is shown if known, otherwise the number. If you have any new missed call records, the button is illuminated and the call log will open showing your missed calls.
 - c. Use the ◀ left and right ▶ arrow keys to select which call log records you are viewing. The options are **All**, **Outgoing** , **Incoming**  and **Missed** . On touch screen phones, press the icon for the type of call log records you want to display.
 - d. Use the ▲ up and down ▼ arrow keys to scroll through the records.
2. Press **More** and then press the **+Contact** soft key.
3. Use the ▲ up and down ▼ arrow keys to switch between the name and number details for the new contact.
4. Using the telephone keypad and the **Bksp** soft key you can edit the name and the number. See [Entering Characters](#)^[158]. When editing the number, use the **Pause** soft key to enter a comma (,) for a 1 second pause in the number dialing.
5. When the name and number are set as required, press the **Save** soft key. To return without saving the name and number, press the **Cancel** soft key.

Chapter 12.

Voicemail

12. Voicemail

If your telephone system includes a voicemail server, pressing the  **MESSAGES** button accesses voicemail. Your system administrator can configure whether the access uses either spoken prompts from the voicemail server or visual menus on the phone called 'visual voice'. This guide assumes the default operation of using the visual voice menus.

Using visual voice, you can access the following functions:

- [Checking Messages](#) ^[75]
- [Record and Send a Message](#) ^[76]
- [Change Your Mailbox Greeting](#) ^[77]
- [Change Your Mailbox Name](#) ^[78]
- [Select a Voicemail Email Mode](#) ^[76]
- [Change Your Voicemail Code](#) ^[78]
- [Turn Use of Voicemail On/Off](#) ^[79]
- [Transfer to Voicemail](#) ^[79]
- [Send a Call to Voicemail](#) ^[79]

Other Functions

This guide covers just the visual voice functions that you can use from the phone's menus. For the full range of mailbox controls that you may be able to use, contact your system administrator for the mailbox user guide appropriate to the type of voicemail server and mailbox mode that your system uses.

Default Short Codes

Short codes are numbers that you can dial to enable and disable various features. The following are default short codes that may be available. However, your system administrator can remove and change the short codes available to you or all users.

- **Check Messages: *17**
Access mailboxes to check for messages.
- **Voicemail On: *18**
Allow voicemail to be used to answer calls.
- **Voicemail Off: *19**
Stop voicemail being used to answer calls.
- **Voicemail Ringback On: *48**
Have voicemail ring your phone when you have any new messages. It will call when you use the phone.
- **Voicemail Ringback Off: *49**
Switch off ringback.

12.1 Message Waiting Indication

Both the  **MESSAGES** button and the message lamp on your phone are used to indicate when you have new messages in your voicemail mailbox. They remain lit until you have played each of the new messages.

The system administrator can also configure it so that you receive new message waiting indications for hunt groups or other users.

12.2 Visual Voice

This menu option provides an alternate route into visual voice if the  **MESSAGES** key has not been setup to do that.

1. Press the **Features** soft key if shown. To do this during a call, press the  **PHONE** key and then press the **Features** soft key.
2. Use the ▲ up and down ▼ arrow keys to highlight **Visual Voice**. Press **Select**.
 - Depending on how your system is configured, you may be required to enter your voicemail password and then press the **Done** soft key.
3. The **Visual Voice** menu is displayed.

Access Control

Your system administrator can configure whether you can access this menu option. See [Menu Access Control](#)^[156].

12.3 Checking Messages

1. Press the  **MESSAGES** button.
 - Depending on how your system is configured, you may be required to enter your voicemail password and then press **Done**.
2. The **Visual Voice** menu is displayed. The numbers shown against the **Listen** option indicate the number of new, old, and saved messages in your mailbox.
 - If the system administrator has configured you to receive message waiting indication for any hunt group mailboxes, you can also use the ▲ up and down ▼ arrow keys to highlight hunt group names and the number of messages in those mailboxes.
3. Highlight **Listen** and press **Select**.
4. Use the ▲ up and down ▼ arrow keys to highlight which messages (**New**, **Old** or **Saved**) that you want to listen to and press **Select**. The details of the first message of that type are displayed.
5. You can use the ▲ up and down ▼ arrow keys to scroll through the messages.
6. Use the soft keys to control the playback actions for the currently highlighted message:
 - **Play / Pause**
Start/stop playback of the currently displayed message.
 - **Call**
Call the person who left the message.
 - **Back**
Return to the previous menu.
 - **More**
Switch between the different sets of available soft key functions.
 - **Delete**
Delete the message.
 - **Save**
Mark the message as saved. Saved messages are not normally automatically deleted.^[1]
 - **Copy**
Copy the message to another mailbox. The menu will prompt you to enter the destination number.

Automatic Message Deletion

By default, messages are automatically deleted a set time after being played. The delay depends on the particular voicemail server (24 hours for embedded voicemail, 30 days for Voicemail Pro). For voicemail messages on a Voicemail Pro system, the system administrator can customize the delay and can also apply automatic deletion times to new and saved messages.

12.4 Sending a Message

You can use visual voice to record and send a voicemail message to other users' mailboxes.

1. Press the  **MESSAGES** button.
 - Depending on how your system is configured, you may be required to enter your voicemail password and then press the **Done** soft key.
2. The **Visual Voice** menu is displayed.
3. Use the ▲ up and down ▼ arrow keys to scroll to the option **Message** and press **Select**.
4. Press **Record** to start recording a messages.
5. To stop recording, press **Stop**.
6. You can now use the following soft keys:
 - **New**
Record the message again.
 - **Send To**
Enter the number to which you want to send the message and press **Add**. You can add several numbers. When the list of numbers to which the message should be sent is complete press **Send**.
 - **Play**
Listen to the recording.
 - **Cancel**
Abandon the message.

12.5 Email Mode

Voicemail email is a feature where emails are sent to your email address when your voicemail mailbox receives a new voicemail message. The email can include the voicemail message as an attachment or it can be just an alert.

Through the **Visual Voice** menu you can change the mode of voicemail email operation.

1. Press the  **MESSAGES** button.
 - Depending on how your system is configured, you may be required to enter your voicemail password and then press the **Done** soft key.
2. The **Visual Voice** menu is displayed.
3. Use the ▲ up and down ▼ arrow keys to scroll to the option **Email**. This option is only available if your email address has been set in your voicemail settings by the system administrator.
4. The menu displays your current voicemail email mode setting. Press **Change** to scroll through the possible settings:
 - **Off**
Do not send any emails.
 - **Copy**
Send an email with a copy of the new voicemail message attached.
 - **Forward**
Send an email with the new voicemail message attached and delete the message from the voicemail mailbox.
 - **Alert**
Send an email telling you there is a new message but do not attach a copy of the message.
6. When the required setting is displayed, press **Save**. To exit without changing the setting, press **Cancel**.

Access Control

Your system administrator can configure whether you can access this menu option. See [Menu Access Control](#)¹⁵⁶.

12.6 Mailbox Greeting

While the voicemail system will play a generic greeting to a caller, prompting them to leave a message, you can record your own greeting.

1. Press the  **MESSAGES** button.
 - Depending on how your system is configured, you may be required to enter your voicemail password and then press the **Done** soft key.
2. The **Visual Voice** menu is displayed.
3. Use the ▲ up and down ▼ arrow keys to scroll to the **Greeting** option and press **Select**.
4. Use the soft keys to listen to and record your mailbox greeting.
 - **Record**
Record a new greeting. Note that the greeting must be at least three seconds long or the voicemail system will discard it.
 - **Listen**
Listen to the current greeting or the new greeting just recorded.
 - **Submit**
Submit the new recording as your mailbox greeting.
 - **More**
Switch between the different sets of available soft key functions.
 - **Delete**
Delete your current mailbox greeting. The greeting will return to its default mailbox greeting.
 - **Cancel**
Return to the main **Visual Voice** menu.

12.7 Mailbox Name

Use the following procedure to record a mailbox name. This feature is only available on systems using Embedded Voicemail.



1. Press the  **MESSAGES** button.
 - Depending on how your system is configured, you may be required to enter your voicemail password and then press the **Done** soft key.
2. The **Visual Voice** menu is displayed.
3. Use the ▲ up and down ▼ arrow keys to scroll to the **Name** option and press **Select**.
4. Use the soft keys to listen to and record your mailbox name.
 - **Record**
Record a new name.
 - **Listen**
Listen to the current name or the name just recorded.
 - **Submit**
Submit the new recording as your mailbox name
 - **More**
Switch between the different sets of available soft key functions.
 - **Delete**
Delete your current mailbox name. The voicemail will use the default name.
 - **Cancel**
Return to the main **Visual Voice** menu.

12.8 Changing Your Voicemail Code

1. Press the  **MESSAGES** button.
 - Depending on how your system is configured, you may be required to enter your current voicemail password and then press the **Done** soft key.
2. The **Visual Voice** menu is displayed.
3. Use the ▲ up and down ▼ arrow keys to scroll to the **Password** option and press **Select**.
4. Enter your current password and press **Save**.
Enter the new password that you want to use.
5. When the desired password is complete, press **Save**.
 - **Code Enforcement**
The system administrator can set rules for the required length of the code and to restrict the use of obvious codes (1234, 1111). The system will not allow save the new code until those requirements have been meet. Contact your system administrator for details of your systems settings if necessary.

12.9 Switching Voicemail On/Off

You can control whether the telephone system uses voicemail to answer your unanswered calls. This does not switch off your mailbox which you can still access to play existing messages and use other functions.

1. Press the  **MESSAGES** button.
 - Depending on how your system is configured, you may be required to enter your voicemail password and then press the **Done** soft key.
2. The **Visual Voice** menu is displayed.
3. Use the  up and down  arrow keys to highlight **Voicemail**.
4. Press the **Change** to switch between **On** or **Off**.
5. Press **Save** to save the change.

12.10 Transferring to Voicemail



When set to visual voice mode, the  key can be used to transfer your current call to the voicemail mailbox of another user or group.

1. With the call connected, press the  key. You are still connected to the call and can continue talking.
2. Dial the extension number of the user or group to which you want to transfer the call.
3. When the number matches a user or group, their name is displayed.
 - To transfer the call to the user or group's mailbox, press **Select**. The caller will hear a few seconds of ringing and then the mailbox greeting.
 - To exit the transfer menu, press **Cancel**.

12.11 Sending a Call to Voicemail

You can transfer a call targeted at you directly to your voicemail mailbox.

To divert a call to your mailbox:

1. If the call is not the currently highlighted call on the display, use the  up and down  arrow keys to highlight it.
2. Press the **To VM** soft key. The call is redirected to your mailbox.

Chapter 13.

Logging In/Out

13. Logging In/Out

You may always use the same phone in the same location. However, the telephone system provides a number of features that allow you to use any phone on the system to make and receive calls.

- **Log In** ⁸³
You can log in at any phone that you want to use. All your calls are then redirected to that phone and your user settings are applied to calls made and received. If it is a phone that stores your contacts and call history on the system, your contacts and call log are displayed by the phone.
 - Any other existing user of that phone is logged out while you are logged in.
 - If you were logged in on another phone, you are logged out from it.
 - If your phone system is in a [Small Community Network \(SCN\)](#) ¹⁶⁵ of phone systems, it may be possible to log in at extensions located on other phone systems in the network. Your system administrator will advise you if you can 'remote hot desk' and what features will still be available to you when you do.
- **Log Out** ⁸⁴
When you log out from a phone, or are logged out by another user logging in, the telephone system may apply several actions:
 - If you have a normal default extension and no one else is logged in there, you return to being logged in on that phone.
 - If you remain logged out, you are treated the same as being on 'do not disturb' except that all calls to you go to voicemail instead, if available.
 - If you have a mobile twinned number, the system administrator can configure the system so that calls are still presented to your mobile twin while you are logged out.
- **Lock/Unlock** ⁸⁴
Separately from logging in and out, you can lock your phone settings. While locked, the phone can still be used to answer your calls and can be used to make internal and emergency calls. However it cannot be used to make external calls and your user settings cannot be accessed through the phones menus.
 - You can set your phone to automatically lock itself after a period of inactivity.
- **Default Extension**
Each extension can be configured with a default user. If you are logged off from an extension, the system will automatically log you in at your default extension if it is not in use by another user.
- **Login Idle Period**
Your system administrator can configure a timeout which will automatically log you out if you do not use the phone in that time to make or answer a call.

Default Short Codes

Short codes are numbers that you can dial to enable and disable various features. The following are default short codes that may be available. However, your system administrator can remove and change the short codes available to you or all users.

- **Log In: *35*N*P#**
Log in to a phone using your extension number (**N**) and login code (**P**).
- **Log Out: *36**
Log yourself out from the phone where you are currently logged in.

13.1 Logging In

When you log in to a phone, you take control of that phone. Incoming calls for you are redirected to that phone and your user information and settings are available. Any existing user on the phone is logged off when you log in.

The method for logging in depends on the current state of the phone:

- **Phone In Use** ^[83]
If the phone is already in use you can still login. The existing user will be logged out.
- **Logged Out** ^[83]
If the phone has no current user, the basic menu with just the login option is displayed.
- **Unregistered Phone** ^[83]
If the phone is not registered with the phone system, the **Enter Extension** menu is displayed.

13.1.1 Logging In on a Phone Already in Use

You can login at a phone that is already in use by another user. The existing user is logged out.

1. If the phone is already in use:
 - Press the **Features** soft key.
 - Use the ▲ up and down ▼ arrow keys to highlight **Phone User**. Press **Select**.
 - Use the ▲ up and down ▼ arrow keys to highlight **Login....** Press **Select**.
2. The login menu is displayed.
3. Enter your extension number and press **Next** .
4. Enter your security PIN (login code).
5. Press **Done**.

Access Control

Your system administrator can configure whether you can access this menu option. See [Menu Access Control](#) ^[156].

13.1.2 Logging In on an Unregistered Phone

This method is used to login at an unregistered phone. You can recognize an unregistered phone by **Enter Extension** on the display. This method is not supported for hot desking on the system; you can only log in using the base extension number originally used to install the phone.

1. Enter your extension number. As you enter it, you can use the **Bksp** and **Clear** soft keys to make corrections.
2. When your number is displayed, press the **OK** soft key.
3. Enter the phone password. Use the **Bksp** and **Clear** soft keys to make corrections.
Note: This password is determined by your system administrator and is required for registration.
4. When you have entered the phone password, press **Done**. If the details are correct, your user details will be loaded into the phone.

13.1.3 Logging In on a Not Logged In Phone

This method is used to login at an extension where the previous user has [logged out](#) ^[84] and the phone has no current user. You can recognize a phone in this state by **NOT LOGGED IN** on the display.

1. Press **Select**.
2. The login menu is displayed.
3. Enter your extension number and press **Next** .
4. Enter your security PIN (login code).
5. Press **Done**.

13.2 Logging Out

1. Press the **Features** soft key if shown. To do this during a call, press the  **PHONE** key and then press the **Features** soft key.
2. Use the ▲ up and down ▼ arrow keys to highlight **Phone User**. Press **Select**.
3. Use the ▲ up and down ▼ arrow keys to highlight **Logout**. Press **Select**.
4. You will be logged out of the phone. The follow action will depend on several factors:
 - If the phone does not have a default user, or the default user is currently logged on elsewhere, the 'no user' display is shown:
 - If the phone has a default user and they are not current logged on elsewhere, they are automatically logged back in.

Access Control

Your system administrator can configure whether you can access this menu option. See [Menu Access Control](#) ^[156].

13.3 Locking the Phone

Rather than logging out, you can lock your phone. You can either lock your phone manually using the steps below or have it automatically locked after a period of phone inactivity. To use the lock feature you need to [set a security PIN](#) ^[85].

When your phone is locked:

- It can only be used to make internal and emergency calls.
- None of the menus for your user settings can be accessed.
- [Unlocking the phone](#) ^[85] requires your login code, if you have [configured a login code](#) ^[85].

To lock your phone manually:

1. Press the **Features** soft key if shown. To do this during a call, press the  **PHONE** key and then press the **Features** soft key.
2. Use the ▲ up and down ▼ arrow keys to highlight **Phone User**. Press **Select**.
3. Use the ▲ up and down ▼ arrow keys to highlight **Lock**. Press the **Select**.
4. The phone is now locked as indicated by the display.

Access Control

Your system administrator can configure whether you can access this menu option. See [Menu Access Control](#) ^[156].

13.4 Auto Lock

Rather than logging out, you can lock your phone. You can either [lock your phone manually](#)^[84] using the steps below or have it automatically locked after a period of phone inactivity. To use this feature you need a [security PIN](#)^[85] (login code) set.

When your phone is locked:

- It can only be used to make internal and emergency calls.
- None of the menus for your user settings can be accessed.
- [Unlocking the phone](#)^[85] requires your login code, if you have [configured a login code](#)^[85].

1. Press the **Features** soft key if shown. To do this during a call, press the  **PHONE** key and then press the **Features** soft key.
2. Use the ▲ up and down ▼ arrow keys to highlight **Phone User**. Press **Select**.
3. Use the ▲ up and down ▼ arrow keys to highlight **Phone Screen Settings**. Press **Select**.
4. Use the ▲ up and down ▼ arrow keys to highlight **Auto Lock (minutes)**.
5. Press the **Change** soft key to change the setting or use the ◀ left or right ▶ arrow keys.
 - **Disabled**
Do not use the inactivity timer.
 - **1 / 5 / 30 / 60**
Lock the phone after the indicated number of minutes.
6. Press the **Save** soft key.

Access Control

Your system administrator can configure whether you can access this menu option. See [Menu Access Control](#)^[156].

13.5 Unlocking the Phone

The message **PHONE LOCKED** indicates that the phone has been [locked](#)^[84]. While locked, the phone can only be used to make internal calls to other extensions and none of the phone and user menus can be accessed.

1. Press the **Unlock** soft key.
2. Enter your security PIN (login code).
3. Press the **Done** soft key.

13.6 Changing Your Security PIN

You can change your own security PIN (login code). If set, this PIN is used for logging in at other phones, [locking your phone](#)^[84], and [accessing system administration features](#)^[146]. This is not your [voicemail code](#)^[78] used for voicemail access.

1. Press the **Features** soft key if shown. To do this during a call, press the  **PHONE** key and then press the **Features** soft key.
2. Use the ▲ up and down ▼ arrow keys to highlight **Phone User**. Press **Select**.
3. Use the ▲ up and down ▼ arrow keys to highlight **Set Security PIN**. Press **Select**.
4. Enter your current security PIN if you already have one and press **Done**.
5. Enter your new password.
6. Press **Save**.
 - **Code Enforcement**
The system administrator can set rules for the required length of the code and to restrict the use of obvious codes (1234, 1111). The system will not allow save the new code until those requirements have been met. Contact your system administrator for details of your systems settings if necessary.

Access Control

Your system administrator can configure whether you can access this menu option. See [Menu Access Control](#)^[156].

Chapter 14.

Redirecting Calls

14. Redirecting Calls

This section looks at the different ways that you can redirect your calls to another phone.

- **Follow Me** 

Temporarily redirect all your calls to another phone that you will be sharing with that phone's normal user. This function can be used in two ways:

 - **Follow Me To**
Set the follow me destination from your own phone.
 - **Follow Me Here**
Set the follow me destination from the phone that you want to use.
- **Forward** 

Forward calls to an internal or external number.

 - **Forward on Busy**
Forward calls when you have reached the limit of the number of calls that the phone can present to you.
 - **Forward on No Answer**
Forward calls if they have rung unanswered at your phone.
 - **Forward Unconditional**
Immediately forward calls. Forwarding to voicemail can be selected as an option.
- **Do Not Disturb** 

Redirect all calls to voicemail, if available. Otherwise, calls are redirected to a busy tone.

 - Do not disturb exception numbers can be used to allow calls from specific numbers to ignore do not disturb.
- **Twinning** 

Twinning is a process whereby you can have your calls ring at two different phones. You can answer calls at either phone. There are two variants of twinning, internal twinning which uses two internal extensions and mobile twinning which twins your internal extension with an external number.

Method		Calls Redirected			Destination		
		Internal	External	Group	Internal	External	Voicemail
Follow Me	Follow Me To	✓	✓	✓	✓	✗	✗
	Follow Me Here	✓	✓	✓	✓	✗	✗
Forward	Forward on Busy	✓	✓	✗	✓	✓	✗
	Forward on No Answer	✓	✓	✗	✓	✓	✗
	Forward Unconditional	✓	✓	✓	✓	✓	✓
Do Not Disturb		✓	✓	✗	✗	✗	✓
Twinning		✓	✓	✓	✓	✓	✓

14.1 Follow Me

'Follow me to' is used to redirect your calls to another extension where you will be working. The calls are presented with your user name so that they can be distinguished from calls for the extensions normal user. This allows you to share another person's phone without logging them off their phone.

All calls are redirected and the calls are still subject to all your user settings as if they were ringing at your phone.

Follow Me To

'Follow me to' is the function used to enable 'follow me' from your own phone.

Follow Me Here

'Follow me here' is the function used to enable 'follow me' at the extension to which you want your calls redirected.

Default Short Codes

Short codes are numbers that you can dial to enable and disable various features. The following are default short codes that may be available. However, your system administrator can remove and change the short codes available to you or all users.

- **Follow Me Here: *12*N#**
Dialed at the extension to which you want your calls redirected. Use your own extension number (**N**) when dialing the short code.
- **Follow Me Here Cancel: *13*N#**
Dialed at the extension from which you had redirected calls. Use your own extension number (**N**) when dialing the short code.
- **Follow Me To: *14*N#**
Dialed at your phone. Dial the extension number (**N**) to which you want your calls redirected. You can dial just ***14#** to cancel follow me.
- **Cancel All Forwarding: *00**
Switch off any forwarding (includes 'forward unconditional,' 'forward on busy,' 'forward on no answer,' 'follow me,' and 'do not disturb').

14.1.1 Follow Me To (Features Menu)

Using the user menu you can set and clear follow me to settings.

1. Press the **Features** soft key if shown. To do this during a call, press the  **PHONE** key and then press the **Features** soft key.
2. Use the ▲ up and down ▼ arrow keys to highlight **Forward**. Press **Select**.
3. Use the ▲ up and down ▼ arrow keys to highlight **Follow Me To**. Press **Select**.
4. Dial the number of another user. When it matches a user, their name is displayed. Alternatively, use the **Dir** soft key to [select a user from the directory](#)^[64].
 - **Save**
Save the selected number as your 'follow me to' destination. All calls to your extension number will be redirected to that destination.
 - **Clear**
Clear the currently selected or set number.
 - **Back**
Go back to the previous menu.

Access Control

Your system administrator can configure whether you can access this menu option. See [Menu Access Control](#)^[156].

14.1.2 Follow Me (Status Menu)

If you have set a 'follow me to' destination for calls to your phone, you can clear or change the setting through the **Status** menu.

1. Press the **Status** soft key if shown.
 - To access the Status menu during a call, press the  **PHONE** key and then press the **Status** soft key if shown.
2. Use the ▲ up and down ▼ arrow keys to highlight **Follow Me To**.
 - To clear the 'follow me to' setting, press the **Clear** soft key.
 - To change the destination of the setting, press the **Details** soft key.

Access Control

Your system administrator can configure whether you can access this menu option. See [Menu Access Control](#)^[156].

14.1.3 Follow Me Here (Features Menu)

You may be able to change 'follow me here' using the Features menu.

1. Press the **Features** soft key if shown. To do this during a call, press the  **PHONE** key and then press the **Features** soft key.
2. Use the ▲ up and down ▼ arrow keys to highlight **Forward**. Press **Select**.
3. Use the ▲ up and down ▼ arrow keys to highlight **Follow Me Here**. Press **Select**.
 - Use the menu to add or remove users.
 - Use the ▲ up and down ▼ arrow keys to scroll through the names.
 - To remove a user, press the **Clear** soft key.
 - To add a user, press the **Add** soft key.
 - Dial the number of another user. When it matches a user, their name is displayed. Alternatively, use the **Dir** soft key to [select a user from the directory](#)^[64].
 - Press the **Save** soft key to set the 'follow me here.'

Access Control

Your system administrator can configure whether you can access this menu option. See [Menu Access Control](#)^[156].

14.2 Forwarding Calls

Forwarding is used to redirect calls to another extension or an external number.

Forward Unconditional

Forward unconditional can be used to immediately redirect your calls.

- By default this function is only applied to incoming external calls made to you. However, if required, internal calls and or hunt group calls can also be selected.
- When enabled, all calls matching the settings are forwarded to the number set as the 'forward unconditional' destination. That number can be internal or external.
- You can still use the phone to make outgoing calls. When you go off-hook you will hear broken dial tone.
- The 'forward on busy' and 'forward on no answer' options use the same forwarding destination number. If no number is set, they use the same destination as set for 'forward unconditional.'
- If you have [voicemail enabled](#) ⁽⁷⁹⁾, the telephone system will attempt to redirect forwarded calls to voicemail if they are still unanswered after having rung for your 'no answer' time (default 15 seconds). This is not always possible for calls that have been forwarded to an external number.
- **D = Diverting (Forwarding) Calls**
A **D** is shown after your extension name on the phone's idle display when you have 'forward unconditional' enabled.

Forward on Busy

'Forward on busy' redirects your calls when your phone is not able to present you with any more alerting calls.

- By default, this function is only applied to incoming external calls made to you. However, if required, internal calls can also be selected.
- When enabled, all calls matching the settings are forwarded to the number set as the 'forward on busy'/'no answer' destination. That number can be internal or external.
- 'Busy' is defined as having no available call appearance buttons on which further calls can be presented.
- Hunt group calls are not presented when you are busy and so are not forwarded by this setting.
- The 'forward on busy' and 'forward on no answer' options use the same forwarding destination number. If no number is set, they use the same destination as set for 'forward unconditional.'
- If you have [voicemail enabled](#) ⁽⁷⁹⁾, the telephone system will attempt to redirect forwarded calls to voicemail if they are still unanswered after having rung for your 'no answer' time (default 15 seconds). This is not always possible for calls that have been forwarded to an external number.

Forward on No Answer

Forward on no answer redirects calls that have alerted your phone but have not been answered.

- By default this function is only applied to incoming external calls to you. However, if required, internal calls can also be selected.
- When enabled, all calls matching the settings are forwarded to the number set as the 'forward on busy'/'no answer' destination. That number can be internal or external.
- No answer is defined as having been presented to your phone for your 'no answer' time (default 15 seconds).
- Hunt group calls are not forwarded.
- The 'forward on busy' and 'forward on no answer' options use the same forwarding destination number. If no number is set, they use the same destination as set for 'forward unconditional.'
- If you have [voicemail enabled](#) ⁽⁷⁹⁾, the telephone system will attempt to redirect forwarded calls to voicemail if they are still unanswered after having rung for your 'no answer' time (default 15 seconds). This is not always possible for calls that have been forwarded to an external number.

Default Short Codes

Short codes are numbers that you can dial to enable and disable various features. The following are default short codes that may be available. However, your system administrator can remove and change the short codes available to you or all users.

- **Cancel All Forwarding: *00**
Switch off any forwarding (includes 'forward unconditional,' 'forward on busy,' 'forward on no answer,' 'follow me,' and 'do not disturb').
- **Set the Forward Unconditional Destination: *07*N#**
Set the destination number (**N**) for 'forward unconditional' when it is switched on.
 - **Switch Forward Unconditional On: *01**
Switch on 'forward unconditional.' A destination must have been set.
 - **Switch Forward Unconditional Off: *02**
 - **Include Hunt Group Calls in Forward Unconditional: *50**
 - **Exclude Hunt Group Calls from Forward Unconditional: *51**
- **Set the Forward On Busy/No Answer Destination: *57*N#**
Set the destination number (**N**) for 'forward on busy' and 'forward on no answer.' If no number has been set, those functions will use the 'forward unconditional' number if set.
 - **Switch Forward On Busy On: *03**
 - **Switch Forward On Busy Off: *04**
 - **Switch Forward on No Answer On: *05**
 - **Switch Forward on No Answer Off: *06**

14.2.1 Forward Unconditional (Status Menu)

You can clear or change your 'forward unconditional' settings through the **Status** menu.

1. Press the **Status** soft key if shown.
 - To access the Status menu during a call, press the  **PHONE** key and then press the **Status** soft key if shown.
2. Use the ▲ up and down ▼ arrow keys to highlight **Fwd Uncon**.
 - To switch off 'forward unconditional,' press the **Off** soft key.
 - To change the forwarding settings, press the **Details** soft key.
 - Use the ▲ up and down ▼ arrow keys to scroll through the editing options.
 - Use the ◀ left and right ▶ arrow keys to switch the forwarding on or off.
 - Use the ◀ left and right ▶ arrow keys to select which calls should be forwarded. The options are **External Only**, **External and Group**, **Non Group Calls**, and **All Calls**.
 - Select edit to change the number to which calls are forwarded.

Access Control

Your system administrator can configure whether you can access this menu option. See [Menu Access Control](#)^[156].

14.2.2 Forward Unconditional (Features Menu)

You may be able to change your 'forward unconditional' settings using the Features menu.

1. Press the **Features** soft key if shown. To do this during a call, press the  **PHONE** key and then press the **Features** soft key.
2. Use the ▲ up and down ▼ arrow keys to highlight **Forward**. Press **Select**.
3. Use the ▲ up and down ▼ arrow keys to highlight **Forward Unconditional**. Press **Select**.
4. The screen will display your current 'forward unconditional' settings.
 - **To Switch Forward Unconditional On/Off**
Highlight **Fwd Unconditional**. Press **On** or **Off** to change the current setting. If no destination is currently set when you switch 'forward unconditional' on, the display will jump to the destination field.
 - **To Select Which Calls as Forwarded**
Highlight **Call Type**. Press **Change** to see the different options. When the required option is displayed press **Save**. The options are **External Only**, **External and Group**, **Non Group Calls** and **All Calls**.
 - **To Set the Forward Destination**
Highlight **Destination**. Either press **Edit** and enter the number required or press **To VM** for the 'forward to voicemail' option.
 - If you select **Voicemail** as the destination, you will need to switch 'forward unconditional' off in order to cancel it and enter a new destination.

Access Control

Your system administrator can configure whether you can access this menu option. See [Menu Access Control](#)^[156].

14.2.3 Forward On Busy/No Answer (Features Menu)

You may be able to use the Features menu to switch 'forward on no answer' and 'forward on busy' on or off.

1. Press the **Features** soft key if shown. To do this during a call, press the  **PHONE** key and then press the **Features** soft key.
2. Use the ▲ up and down ▼ arrow keys to highlight **Forward**. Press **Select**.
3. Use the ▲ up and down ▼ arrow keys to highlight **Fwd Busy/No Answer**. Press **Select**.
 - Use the ▲ up and down ▼ arrow keys to scroll through the menu options.
 - To switch 'forward on busy' on or off, highlight **Fwd Busy** and press **On** or **Off**.
 - To switch 'forward on no answer' on or off, highlight **Fwd No Answer** and press **On** or **Off**.
 - To select which calls are forwarded highlight **Call Type**. Press **Change** to change the option between **All Calls** or **External Calls Only**.
 - To change the destination highlight **Destination** and press **Edit**. Enter the number and press **Select**.
 - Press **Save** to save any changes.

Access Control

Your system administrator can configure whether you can access this menu option. See [Menu Access Control](#)^[156].

14.2.4 Forward On No Answer (Status Menu)

If your phone is set to [forward on no answer](#)^[163] you can clear or change the forward settings through the **Status** menu.

1. Press the **Status** soft key if shown.
 - To access the Status menu during a call, press the  **PHONE** key and then press the **Status** soft key if shown.
2. Use the ▲ up and down ▼ arrow keys to highlight **Fwd No Answer**.
3. To switch the forward off press **Off**.
4. To change the forward setting press **Details**.
 - Use the ▲ up and down ▼ arrow keys to scroll through the menu options.
 - To switch 'forward on busy' on or off, highlight **Fwd Busy** and press **On** or **Off**.
 - To switch 'forward on no answer' on or off, highlight **Fwd No Answer** and press **On** or **Off**.
 - To select which calls are forwarded highlight **Call Type**. Press **Change** to change the option between **All Calls** or **External Calls Only**.
 - To change the destination highlight **Destination** and press **Edit**. Enter the number and press **Select**.
 - Press **Save** to save any changes.

Access Control

Your system administrator can configure whether you can access this menu option. See [Menu Access Control](#)^[156].

14.2.5 Forward On Busy (Status Menu)

If your phone is set to 'forward on busy,' you can clear or change the forward settings through the **Status** menu.

1. Press the **Status** soft key if shown.
 - To access the Status menu during a call, press the  **PHONE** key and then press the **Status** soft key if shown.
2. Use the ▲ up and down ▼ arrow keys to highlight **Fwd Busy**.
3. To switch the forward off press **Off**.
4. To change the forward setting press **Details**.
 - Use the ▲ up and down ▼ arrow keys to scroll through the menu options.
 - To switch 'forward on busy' on or off, highlight **Fwd Busy** and press **On** or **Off**.
 - To switch 'forward on no answer' on or off, highlight **Fwd No Answer** and press **On** or **Off**.
 - To select which calls are forwarded highlight **Call Type**. Press **Change** to change the option between **All Calls** or **External Calls Only**.
 - To change the destination highlight **Destination** and press **Edit**. Enter the number and press **Select**.
 - Press **Save** to save any changes.

Access Control

Your system administrator can configure whether you can access this menu option. See [Menu Access Control](#)¹⁵⁶.

14.3 Do Not Disturb

- When you are in 'do not disturb,' your callers are redirected to voicemail if available. Otherwise, you hear a busy tone.
- The only people who can call you are those calling from numbers in your 'do not disturb' exceptions list. Forwarding can still be applied to these calls.
- Calls to any hunt group of which you are a member are not presented to you (unless you are the last available member of the group).
- Enabling 'do not disturb' will not affect any calls already being presented to your phone.
- You can still use the phone to make outgoing calls. When you go off-hook you will hear broken dial tone.
- **N = No Calls (Do Not Disturb)**
An **N** is shown after your extension name on the phone's idle display when you have 'do not disturb' enabled.

Default Short Codes

Short codes are numbers that you can dial to enable and disable various features. The following are default short codes that may be available. However, your system administrator can remove and change the short codes available to you or all users.

- **Switch Do Not Disturb On: *08**
Set your phone to 'do not disturb.'
- **Switch Do Not Disturb Off: *09**
Switch off 'do not disturb.'
- **Add a Do Not Disturb Exception Number: *10*N#**
Add a number (**N**) to your list of 'do not disturb' exceptions.
- **Delete a Do Not Disturb Exception Number: *11*N#**
Remove a number (**N**) from your list of 'do not disturb' exceptions.
- **Cancel All Forwarding: *00**
Switch off any forwarding (includes 'forward unconditional,' 'forward on busy,' 'forward on no answer,' 'follow me,' and 'do not disturb').

14.3.1 DND On/Off (Features Menu)

You can use the Features menu to switch 'do not disturb' (DND) on or off. Enabling DND will not affect any calls already being presented to your phone. Hunt group calls will also still be presented if you are the only available member of the group.

1. Press the **Features** soft key if shown. To do this during a call, press the  **PHONE** key and then press the **Features** soft key.
2. Use the ▲ up and down ▼ arrow keys to highlight **Call Settings**. Press **Select**.
3. Press **Change** to change the setting.
4. Press **Save** to save the setting.

Access Control

Your system administrator can configure whether you can access this menu option. See [Menu Access Control](#) ^[156].

14.3.2 DND Off (Status Menu)

You can use the **Status** menu to switch off 'do not disturb.'

1. Press the **Status** soft key if shown.
 - To access the Status menu during a call, press the  **PHONE** key and then press the **Status** soft key if shown.
2. If necessary use the ▲ up and down ▼ arrow keys to highlight **Do Not Disturb**.
 - To clear the 'do not disturb' setting, press the **Off** soft key.

Access Control

Your system administrator can configure whether you can access this menu option. See [Menu Access Control](#) ^[156].

14.3.3 Do Not Disturb Exceptions

These numbers are used to indicate callers who you want to be allowed to call you as normal even when you have 'do not disturb' on. This does not include group calls which are not presented when you are in 'do not disturb'.

1. Press the **Features** soft key if shown. To do this during a call, press the  **PHONE** key and then press the **Features** soft key.
2. Use the ▲ up and down ▼ arrow keys to highlight **Call Settings**. Press **Select**.
3. Use the ▲ up and down ▼ arrow keys to highlight **DND Exceptions**. Press **Select**.
4. To add a number, highlight **Add Another**. Dial the number and press **Add**.
5. To remove an existing number, highlight it and press **Remove**.
6. Press **Done** when completed.

Access Control

Your system administrator can configure whether you can access this menu option. See [Menu Access Control](#) ^[156].

14.4 Twinning

Twining is a process whereby your calls ring on two phones. Twining is only available if configured by your system administrator.

The system supports two twinning methods: [internal twinning](#)^[164] and [mobile twinning](#)^[165].

Internal Twinning

This method of twinning twins your normal phone with another internal phone. Your incoming calls will ring on both phones. You can also make your calls from either extension.

A typical example for internal twinning would be a user who uses both a normal desk phone and also needs a mobile phone while moving around the building.

Your settings are applied to both phones. Similarly, message waiting indication and voicemail access from either phone will be to your mailbox.

If both phones are phones that store your contacts and call history on the system, the contacts and call history on each will be the same.

- **T = Twinned**

A **T** is shown after your extension name on the phone's idle display if it is internally twinned with your phone. Calls to you will alert on both phones and can be answered by you at either phone.

Mobile Twinning

Mobile [twinning](#)^[165] allows your calls to ring at both your phone's and at another phone's number, which can include an external number. If you have been configured as a mobile twinning user, you can switch the use of mobile twinning on or off through the phone's menus and can also change the number to which you are twinned.

Using the phone menus, you can switch use of mobile twinning on/off and change the destination number for twinned calls.

14.4.1 Mobile Twinning Control

This menu option is only available if you have been configured by the system administrator to be able to use mobile twinning.

- Setting a button to the **Twining** function is recommended—contact your system administrator. Such a button allows you to transfer calls to your twinning destination, retrieve calls from the twinning destination, and access the menu options below to set the twinning destination number and switch twinning on/off.

1. Press the **Features** soft key if shown. To do this during a call, press the  **PHONE** key and then press the **Features** soft key.
2. Use the ▲ up and down ▼ arrow keys to highlight **Forward**. Press **Select**.
3. Use the ▲ up and down ▼ arrow keys to highlight **Mobile Twinning**. Press **Select**.
4. If no twinning number has been set, the menu will prompt you to enter a number.
5. When a number has been entered, you can access the **Enable** and **Disable** soft keys to turn use of mobile twinning on or off. The **Clear** soft key removes the existing twinning number in order to allow entry of a new number.

14.4.2 Transferring a Call to Your Mobile

If you have been configured as a mobile twinning user, you can transfer a call to your mobile device using the features menu.

1. Press the **Features** soft key if shown. To do this during a call, press the  **PHONE** key and then press the **Features** soft key.
2. If necessary, use the ▲ up and down ▼ arrow keys to highlight **Transfer to Mobile**. Press **Select**.

Access Control

Your system administrator can configure whether you can access this menu option. See [Menu Access Control](#)^[156].

14.4.3 Reclaiming a Twinned Call

When using mobile twinning, you can use the status menu to take back a call that has been redirected to and answered at your mobile twinning destination.

1. Press the **Status** soft key if shown.
 - To access the Status menu during a call, press the  **PHONE** key and then press the **Status** soft key if shown.
2. If necessary use the ▲ up and down ▼ arrow keys to scroll the menu to **Mobile Twin Call**.
3. Press **Connect**.

14.4.4 Switching Twinning Off

If you have been configured as a mobile twinning user, you can use the status menu to switch mobile twinning mode off.

1. Press the **Status** soft key if shown.
 - To access the Status menu during a call, press the  **PHONE** key and then press the **Status** soft key if shown.
2. If necessary use the ▲ up and down ▼ arrow keys to highlight **Mobile Twinning**.
 - To clear the setting, press the **Off** soft key.

Chapter 15.

Groups

15. Groups

Your system administrator can include you as a member of a group along with other users. Each group has its own extension number which can be used as the destination for a call.

When a call is made to a group, it is presented to the available group members, either one at a time or all at the same time, until answered by one of the members.

How long a group call will ring at each group member before being presented to the next member is controlled by the group's own settings. Hunt groups also use voicemail and have their own settings for when an unanswered call should go to the group's mailbox. For group calls, the hunt group's voicemail settings are used rather than your settings.

The system administrator can enable a number of hunt group menu options on your phone. Each option is enabled for a selected hunt group or hunt groups of which you are a member:

- **[Enable/Disable Your Group Membership](#)** ⁽¹⁰³⁾
When your membership of a hunt group is disabled, you no longer receive hunt group calls for that group. You are still a member of the group and can re-enable your membership.
- **[Change the Hunt Group Service Status](#)** ⁽¹⁰⁴⁾
Each hunt group can either be in service, in night service, or out of service. When in night service or out of service, the groups calls are redirected to an alternate group, or to voicemail if available.
- **[Change the Hunt Group Fallback Destination](#)** ⁽¹⁰⁴⁾
These menus allow you to change the alternate groups used for the group's calls when it is in night service or out of service status.

Default Short Codes

Short codes are numbers that you can dial to enable and disable various features. The following are default short codes that may be available. However, your system administrator can remove and change the short codes available to you or all users.

- **Night Service Status On: *20*N#**
Set a hunt group into night service status by entering its extension number (**N**).
- **Night Service Status Off: *21*N#**
Take a hunt group out of night service status by entering its extension number (**N**).

15.1 Group Membership

Only the system administrator can change a group, the group members, or group settings. However, you can be provided with options to enable or disable your group membership. While membership to a group is disabled, you will not receive any group calls for that group.

15.1.1 Group Membership On/Off (Status Menu)

Your system administrator can grant you the ability to enable/disable your membership to a group through the **Status** menu. When your membership to a group is disabled, you do not receive group calls for that group.

1. Press the **Status** soft key if shown.
 - To access the Status menu during a call, press the  **PHONE** key and then press the **Status** soft key if shown.
 2. Use the ▲ up and down ▼ arrow keys to highlight the hunt group name and your current membership status (**Enabled** or **Disabled**).
 3. Press the **Enable** or **Disable** soft key to change the status of your membership to that group.
 4. Press **Exit**.
- **!** The system administrator is able to configure whether you have access to the **Membership**, **State** and **Fallback** options of a group. If you are not configured for any groups then the **Group** menu is not shown.

15.1.2 Group Membership On/Off (Features Menu)

You may be able to enable or disable your group membership for some of the groups to which you belong.

1. Press the **Features** soft key if shown. To do this during a call, press the  **PHONE** key and then press the **Features** soft key.
 2. Use the ▲ up and down ▼ arrow keys to highlight **Group**. Press **Select**.
 3. Use the ▲ up and down ▼ arrow keys to highlight **Membership**. Press **Select**.
 4. Use the ▲ up and down ▼ arrow keys to scroll through the list of hunt groups you can configure.
 5. To change your membership to the highlighted group press **Change**.
 - To change your membership to all groups, press **More** and then press either **All Ena** or **All Dis**.
- **!** The system administrator is able to configure whether you have access to the **Membership**, **State** and **Fallback** options of a group. If you are not configured for any groups then the **Group** menu is not shown.

15.2 Group Service Status and Fallback

- **Group Service Status**

A hunt group can be in one of the following service modes:

- **In Service (InS)**

The group operates as normal, distributing calls to available members of the group.

- **Night Service (NS)**

The group is in 'night service' mode. Calls are redirected to its night service fallback destination [if set](#)^[106], otherwise to voicemail if available. A hunt group can also be put into and out of night service automatically by the telephone system using a time profile.

- **Out of Service OOS**

The group is out of service. Calls are redirected to its out of service fallback destination [if set](#)^[106], otherwise to voicemail if available. The phone displays an **O** when one of the groups of which you are a member is out of service. See [Status Letters](#)^[22].

- **Time Profile (TP)**

This setting indicates that the group's status is being controlled by a time profile on the telephone system. That time profile sets when the group is in service and in night service. You can override this to put the group into the **Out of Service** state. You can then use the phone to return the group to time profile control when required.

- **Fallback Destination**

For the night service and out of service states, the hunt group can be configured with a fallback destination to which its calls are redirected. This destination can be another hunt group or user extension. If no fallback destination is set, the group's voicemail is used (if available). Separate night service and out of service fallback destinations can be set for each group.

Display Icon

- **O = Out of Service**

When a group is set to night service mode, all members of that group retain an 'out of service' status indicated by an **O** on the idle display. Calls are diverted to the group's fallback, if set. Otherwise, the calls are sent to voicemail (if available).

- **!** The system administrator is able to configure whether you have access to the **Membership, State** and **Fallback** options of a group. If you are not configured for any groups then the **Group** menu is not shown.

15.2.1 Changing the Group Service Status (Features Menu)

Using the Features menu you may be able to change the service status of some groups to which you belong.

1. Press the **Features** soft key if shown. To do this during a call, press the  **PHONE** key and then press the **Features** soft key.
 2. Use the ▲ up and down ▼ arrow keys to highlight **Group**. Press **Select**.
 3. Use the ▲ up and down ▼ arrow keys to highlight **State**. Press **Select**.
 4. Use the ▲ up and down ▼ arrow keys to scroll through the list of hunt groups you can configure. The current status of each group is shown next to the group name.
 - **In Service (InS)**
The groups operates as normal, distributing calls to available members of the group.
 - **Night Service (NS)**
The group is in 'night service' mode. Calls are redirected to its night service fallback destination [if set](#)^[106], otherwise to voicemail if available. A hunt group can also be put into and out of night service automatically by the telephone system using a time profile.
 - **Out of Service OOS**
The group is out of service. Calls are redirected to its out of service fallback destination [if set](#)^[106], otherwise to voicemail if available. The phone displays an **O** when one of the groups of which your are a member is out of service. See [Status Letters](#)^[22].
 - **Time Profile (TP)**
This setting indicates that the group's status is being controlled by a time profile on the telephone system. That time profile sets when the group is in service and in night service. You can override this to put the group into the **Out of Service** state. You can then use the phone to returns the group to time profile control when required.
 5. Use the controls at the bottom on the display to change the currently selected group's status.
 - **Change**
Change the status of the selected group.
 - **Save**
Exit the menus.
- **!** The system administrator is able to configure whether you have access to the **Membership, State** and **Fallback** options of a group. If you are not configured for any groups then the **Group** menu is not shown.

15.2.2 Changing the Group Service Status (Status Menu)

If the system administrator has allowed you, you can change the service state of a group through the **Status** menu.

1. Press the **Status** soft key if shown.
 - To access the Status menu during a call, press the  **PHONE** key and then press the **Status** soft key if shown.
 2. Use the ▲ up and down ▼ arrow keys to highlight the hunt group name and your current membership status.
 3. Select the required state using the soft keys:
 - **In Service (InS)**
The groups operates as normal, distributing calls to available members of the group.
 - **Night Service (NS)**
The group is in 'night service' mode. Calls are redirected to its night service fallback destination [if set](#)^[106], otherwise to voicemail if available. A hunt group can also be put into and out of night service automatically by the telephone system using a time profile.
 - **Out of Service OOS**
The group is out of service. Calls are redirected to its out of service fallback destination [if set](#)^[106], otherwise to voicemail if available. The phone displays an **O** when one of the groups of which your are a member is out of service. See [Status Letters](#)^[22].
 - **Time Profile (TP)**
This setting indicates that the group's status is being controlled by a time profile on the telephone system. That time profile sets when the group is in service and in night service. You can override this to put the group into the **Out of Service** state. You can then use the phone to returns the group to time profile control when required.
- **!** The system administrator is able to configure whether you have access to the **Membership, State** and **Fallback** options of a group. If you are not configured for any groups then the **Group** menu is not shown.

15.2.3 Changing the Fallback Destinations

You may be able to use the **Features** menu to change the fallback destination for some hunt groups of which you are a member. These are the destinations to which the hunt groups calls are routed when it is in either night service state or the out of service state. The destination can be another group, another user or a dialing code configured by you system administrator.

1. Press the **Features** soft key if shown. To do this during a call, press the  **PHONE** key and then press the **Features** soft key.
2. Use the ▲ up and down ▼ arrow keys to highlight **Group**. Press **Select**.
3. Use the ▲ up and down ▼ arrow keys to highlight **Fallback**. Press **Select**.
 - Use the ◀ left and right ▶ arrow keys to switch between altering night service or out of service settings.
 - Use the ▲ up and down ▼ arrow keys to scroll through the list of hunt groups you can configure in the current mode.
 - To change the fallback destination of the currently highlighted hunt group, press **Edit**.
 - To change the fallback destination of all the hunt groups, press **More** and then press **Edit All**.
- **!** The system administrator is able to configure whether you have access to the **Membership**, **State** and **Fallback** options of a group. If you are not configured for any groups then the **Group** menu is not shown.

Chapter 16.

Button Features

16. Button Features

Functions can be assigned to the phone's feature buttons by your system administrator or by yourself using self-administration. Note how you cannot replace features assigned to buttons by your system administrator but you can replace other features. Note also that there are features that the system administrator can assign that are not available for you to assign. This guide includes only the features that are available for you to assign if required.

These options are only available if configured by your system administrator.

Button Lamps

The use of the button lamp or icon will depend on the action associated with the button.

Fixed Buttons

On all the phones, the programmable button features appear below the call appearance buttons. The screen can be scrolled to display further buttons. For the 9650 phones, some of the programmable buttons remain permanently visible even if the display is scrolled. On the 9641 phone, you can select to have some of the programmable buttons [permanently visible](#) ^[128].

16.1 Editing Your Programmable Buttons

Self Administer is used to select and apply a function to a feature key. It can be used to replace or delete existing functions.

1. Press the **Features** soft key if shown. To do this during a call, press the  **PHONE** key and then press the **Features** soft key.
2. Use the ▲ up and down ▼ arrow keys to highlight **Phone User**. Press **Select**.
3. Use the ▲ up and down ▼ arrow keys to highlight **Self-Administer**. Press **Select**.
4. Enter your security PIN and press **Done**.
5. On 9621 and 9641 phones, select **Button Features**. Use the ▲ up and down ▼ arrow keys to scroll through the list of current functions assigned to each button.
 - To remove the existing function from a button press **Erase**.
 - You can also press **More** and use the **Copy** and **Paste** options to copy the settings of an existing button to another button.
 - To assign a function to the highlighted button press **Replace**.
 - Select the required function from the list and press **Select**.
 - Depending on the function, you may need to enter some information such as a target extension number.
 - The button will be given a default label. To change the label, press **More** and then select **Label**. Use the keyboard to enter the text you want to display for the button label. Note that the label is only shown while editing the label and after you exit the administration menu.
7. When completed press **Back**.

Access Control

Your system administrator can configure whether you can access this menu option. See [Menu Access Control](#) ^[156].

16.2 Features

There are a wide range of features that can be assigned to the buttons. This guide only lists those that you can assign to a button using the self-administer menu. Functions that can only be assigned by your system administrator will be explained by the system administrator.

- [Abbreviated Dial](#) ^{[109]*}
- [Absence Text](#) ^{[109]*}
- [Account Code](#) ^[109]
- [Call Forward All](#) ^{[109]*}
- [Call Park](#) ^[109]
- [Call Park To Other](#) ^[109]
- [Call Pickup](#) ^{[109]*}
- [Call Pickup Any](#) ^{[109]*}
- [Conf Meet Me](#) ^[109]
- [Drop Call](#) ^[109]
- [Flash Hook](#) ^[110]
- [Group BLF](#) ^[110]
- [Internal Auto Answer](#) ^[109]
- [Page](#) ^{[110]*}
- [Park and Page](#) ^[110]
- [Ringer Off](#) ^[110]
- [Self Administer](#) ^{[110]*}
- [Send All Calls](#) ^{[110]*}
- [Suppress Digits](#) ^[110]
- [User BLF](#) ^[110]
- [Twinning](#) ^[110]

Some actions are not supported on all phones. However, they may be set for users who hot desk between different types of phone. On 9621 and 9641 phones, those functions marked by a * can be assigned to a [quick touch line](#) ^[128] button on the phone's [home screen](#) ^[114].

16.2.1 Abbreviated Dial

This action can be used as a speed dial button. While setting up the button, enter the number you would like it to dial.

You can enter a partial number and complete the dialing after pressing the button. For example, you can pre-program a button with a particular international dialing code.

16.2.2 Absence Text

Set or clear an absence text message for display on your phone. This text also appears on the display of the phone making the incoming call. When setting the message, you can select from a number of pre-configured messages and then add your own text if you want.

16.2.3 Account Code

This action can be set with or without an account code.

If the button is set with an account code, that account code is applied to the current call when the button is pressed.

If the button is set without an account code, pressing the button will display the [enter account code](#)  menu.

16.2.4 Auto Answer

A button configured with this action can be used to switch 'internal auto-answer' on or off. When 'internal auto-answer' is on, the button's red lamp is lit. Pressing the button again turns 'internal auto-answer' off.

16.2.5 Call Forward All

A button with this action can be used to switch 'forwarding unconditional' on/off.

If set with a preset number, that number is used as the forwarding destination.

If set without a number, when the button is pressed you will be asked to confirm your existing 'forward unconditional' destination number or to enter a new number.

The button's red lamp is lit when forwarding is enabled. On touch screen phones an icon is displayed. The button can be pressed again to switch 'forward unconditional' off.

16.2.6 Call Park

A button set to this action can be used to park and unpark calls. The button can be set with or without a park slot number.

- When associated with a specific park slot number, the button can park and unpark a call from that park slot. When a call has been parked in that park slot, the button's lamp flashes. Green if the call was parked using that button, red if parked by another method. Pressing the button again retrieves the call.
- When not associated with a specific park slot number:
 - If pressed while you have a call connected, that call is parked using a park slot number assigned by the system based on your extension number.
 - If pressed while you have no call connected, your phone displays details of your parked calls and allow you to unpark a selected call.
 - When you have calls that you parked (other than Park & Page) or others parked against your extension, the button's lamp flashes.

16.2.7 Call Park to Other

A button set with this action can be used to park a call against another extension. The park slot number used will be based on your extension number.

The button can be set with a target user number or left blank for number entry when the button is pressed. The button's red lamp is lit when a call is parked. The button can be pressed again to retrieve the call.

16.2.8 Call Pickup

Answer a call ringing a user or hunt group.

The target user or group number from which to pickup a call can be set when the button is configured. If no number is set, pressing the button will display a menu for number entry.

16.2.9 Call Pickup Any

Answer a call currently ringing on the telephone system.

16.2.10 Conf Meet Me

A button programmed to this feature allows you to start or enter a conference by entering the conference ID.

16.2.11 Drop Call

This action can be used to drop your current call without having to highlight it on the display. If the call is connected, pressing the key ends the call. If the call is ringing it may follow several routes, see [Dropping an Incoming Call](#) .

16.2.12 Flash Hook

A button configured for this action will send a flash hook signal to a currently connected analog line.

16.2.13 Group BLF

A button can be programmed to indicate if there are any calls to a group waiting to be answered. A red flashing lamp indicates that there are calls waiting for the hunt group. Press the button to pickup the longest waiting call.

16.2.14 Page

A button configured with this action can be used to make a page call.

The button can be configured with the target user or group for the page. If configured without a number, pressing the button will display a menu for number entry before making the page call.

16.2.15 Park and Page

If your system administrator has configured your system for [Park & Page](#)^[42], this button allows you to use the feature to park calls and announce the parked call to other users.

16.2.16 Ringer Off

A button configured with this action can be used to turn your phone's ringer on or off.

When you turn the ringer off the visual alerting is also turned off. When the ringer has been turned off, the button's red lamp is lit. Pressing the button again will turn the ringer on.

16.2.17 Self Administer

A button configured for this action can be used to access the [Self Administer](#)^[108] menu.

16.2.18 Send All Calls

A button configured with this action can be used to switch '[do not disturb](#)^[96]' on or off. When 'do not disturb' is on, the button's red lamp is lit or a red warning icon is displayed. Pressing the button again turns 'do not disturb' off.

16.2.19 Suppress Digits

Masks the display of digits as you dial them on the phone. Dialed digits are replaced with an **s** character. The button is used to switch the suppression on/off. When 'suppress digits' has been set, the button's red lamp is lit. Pressing the button again cancels the suppression.

- If [en-block](#)^[26] dialing is active you will see the digits as you dial them. When you make the call the digits will be suppressed.
- When the option to suppress digits is used, the call is not recorded in the call log.

16.2.20 Twinning

A button configured for this feature allows you to control your phone's mobile twinning operation. This is only useable if your system administrator has configured you for mobile twinning.

- If pressed when the phone is idle, the phone displays the [mobile twinning menu](#)^[98]. You can use the menu to switch mobile twinning on/off and to setting the twinned destination.
- If pressed while a twinned call is connected to the twinned destination, the system attempts to reclaim the call.
- If pressed while connected to a call on the phone, the system attempts to transfer the call to the twinned destination. You do not need twinning switched on to use this feature.

16.2.21 User BLF

This type of button can be used to monitor the status of another user. The lamp's state will indicate the status of the user.

- **Off = Available**
Pressing the button will make a call to the user. In addition to calling the user, you can use the user button to transfer calls to the user or to start a conference with the user.
- **Slow Flash = Ringing**
Pressing the button will display options to pickup the call.
- **Fast Flash = On a Call**
Pressing the button will display a number of options:
 - **Call** - Call the user.
 - **Message** - Cause a single burst of ringing on the user's phone. They will also see the message "**Please Call**" followed by your extension number.
 - **Voicemail** - Call the user's voicemail mailbox to leave a message.

- **Auto Callback** - Set an automatic callback on the user. The callback will occur when the user ends their current call.

The following options are only available if configured for you by your system administrator:

- **Drop Call** - Disconnect the user's current call.
- **Acquire** - Seize the user's current call.
- **Intrude** - Join the user's current call, turning it into a conference call.
- **Listen** - Start silent monitoring of the user's call.

Chapter 17.

Home Screen

17. Home Screen

The 9621 and 9641 phones have a home screen that contains a number of icons for accessing functions. Some of the icons are configured by your system administrator, some are fixed. You can [add up to 8 icons](#)^[113] to access special functions.

The screen is accessed by pressing the **A HOME** key. To exit the screen press the  **PHONE** key.

Display the Home Screen When Idle

The [home screen](#)^[114] used on 9621 and 9641 phones can be set to automatically display if the phone is idle for over 10 minutes.

1. Press the **A MENU/HOME** button and select **Settings**.
2. Use the **▲** up and down **▼** arrow keys to highlight **Options & Settings**. Press **Select**.
3. Use the **▲** up and down **▼** arrow keys to highlight **Screen & Sound Options**. Press **Select**.
4. Select **Return to Home Screen** to change the current setting for that function.
5. Press **Save**.

17.1 Editing Your Home Screen

There are a wide range of actions that can be assigned to the buttons. This guide only includes details of those that you can assign to a button using the self-administer menu. Functions that can only be assigned by your system administrator will be explained by the system administrator.

- Abbreviated Dial*
- Absence Text*
- [Auto Intercom](#)^[116]
- Call Forward All*
- Call Pickup*
- Call Pickup Any *
- Page*
- Self Administer*
- Send All Calls*

Those functions marked as * can also be assigned to [programmable buttons](#)^[108].

1. Press the **Features** soft key if shown. To do this during a call, press the  **PHONE** key and then press the **Features** soft key.
2. Use the ▲ up and down ▼ arrow keys to highlight **Phone User**. Press **Select**.
3. Use the ▲ up and down ▼ keys to highlight **Self-Administer**. Press **Select**.
4. Enter your security PIN and press **Done**.
5. Select **Home Screen Favorites**.
6. Use the ▲ up and down ▼ keys to scroll through the list of current functions assigned to each button.
 - To remove the existing function from a button press **Erase**.
 - You can also press **More** and use the **Copy** and **Paste** options to copy the settings of an existing button to another button.
 - To assign a function to the highlighted button press **Replace**.
 - Select the required function from the list and press **Select**.
 - Depending on the function, you may need to enter some information such as a target extension number.
 - The button will be given a default label. To change the label, press **More** and then select **Label**. Use the keyboard to enter the text you want to display for the button label. Note that the label is only shown while editing the label and after you exit the administration menu.
7. When completed press **Back**.

17.2 Abbreviated Dial

This action can be used as a speed dial button. While setting up the button, enter the number you would like it to dial.

You can enter a partial number and complete the dialing after pressing the button. For example, you can pre-program a button with a particular international dialing code.

17.3 Absence Text

Set or clear an absence text message for display on your phone. This text also appears on the display of the phone making the incoming call. When setting the message, you can select from a number of pre-configured messages and then add your own text if you want.

17.4 Auto Intercom

Make a call to another extension that will be connected without ringing if the other phone supports 'auto-answer.'

17.5 Call Forward All

A button with this action can be used to switch 'forwarding unconditional' on/off.

If set with a preset number, that number is used as the forwarding destination.

If set without a number, when the button is pressed you will be asked to confirm your existing 'forward unconditional' destination number or to enter a new number.

The button's red lamp is lit when forwarding is enabled. On touch screen phones an icon is displayed. The button can be pressed again to switch 'forward unconditional' off.

17.6 Call Pickup

Answer a call ringing a user or hunt group.

The target user or group number from which to pickup a call can be set when the button is configured. If no number is set, pressing the button will display a menu for number entry.

17.7 Call Pickup Any

Answer a call currently ringing on the telephone system.

17.8 Page

A button configured with this action can be used to make a page call.

The button can be configured with the target user or group for the page. If configured without a number, pressing the button will display a menu for number entry before making the page call.

17.9 Self Administer

A button configured for this action can be used to access the [Self Administer](#) ^[108] menu.

This option is only available if configured by your system administrator.

17.10 Send All Calls

A button configured with this action can be used to switch 'do not disturb' ^[96] on or off. When 'do not disturb' is on, the button's red lamp is lit or a red warning icon is displayed. Pressing the button again turns 'do not disturb' off.

Chapter 18.

Phone Settings

18. Phone Settings

Pressing the **A MENU/HOME** key accesses a menu that can be used to control various phone settings. These are mainly settings stored by the phone rather than user settings that move with you.

General	Display Controls
<ul style="list-style-type: none"> • Mobile Twinning ^[119] • Withhold Number ^[119] • Redial Mode ^[119] • Backup/Restore ^[132] • Debug Mode ^[152] • En-Bloc Dialing ^[120] 	<ul style="list-style-type: none"> • Display Brightness ^[128] • Display Contrast ^[128] • Call Timer ^[128] • Show Last Call Duration ^[128] • Display Language ^[128] • Show Waiting Calls ^[127] • Exit Menu Inactivity Timer (Auto Return) ^[128] • Quick Touch Lines ^[128]
Sounds	Ringer Controls
<ul style="list-style-type: none"> • Button Clicks ^[130] • Error Tones ^[130] • Ringer Volume ^[130] • Handset Volume ^[131] • Headset Volume ^[131] • Speaker Volume ^[131] • Automatic Gain Control • Default Audio Path ^[131] 	<ul style="list-style-type: none"> • Switch the Ringer On/Off ^[121] • Flash the message lamp for calls (Visual Alerting) ^[124] • Coverage Ring ^[124] • Ring Sound ^[122] • Ring Volume ^[124] • Internal Auto Answer ^[124]

18.1 Mobile Twinning

This menu option is only available if you have been configured by the system administrator to be able to use mobile twinning.

- Setting a button to the **Twinning** function is recommended—contact your system administrator. Such a button allows you to transfer calls to your twinning destination, retrieve calls from the twinning destination, and access the menu options below to set the twinning destination number and switch twinning on/off.

1. Press the **Features** soft key if shown. To do this during a call, press the  **PHONE** key and then press the **Features** soft key.
2. Use the ▲ up and down ▼ arrow keys to highlight **Forward**. Press **Select**.
3. Use the ▲ up and down ▼ arrow keys to highlight **Mobile Twinning**. Press **Select**.
4. If no twinning number has been set, the menu will prompt you to enter a number.
5. When a number has been entered, you can access the **Enable** and **Disable** soft keys to turn use of mobile twinning on or off. The **Clear** soft key removes the existing twinning number in order to allow entry of a new number.

18.2 Withhold Number

You can select to withhold your number on external calls. Note that this option may not be supported in all situations. It may depend on the configuration of your phone system and options supported by your telephone line provider.

1. Press the **Features** soft key if shown. To do this during a call, press the  **PHONE** key and then press the **Features** soft key.
2. Use the ▲ up and down ▼ arrow keys to highlight **Call Settings**. Press **Select**.
3. Use the ▲ up and down ▼ menu keys to highlight **Withhold Number**.
4. Press **Change** to switch the option **On** or **Off**.
5. Press **Save**.

Access Control

Your system administrator can configure whether you can access this menu option. See [Menu Access Control](#) ⁽¹⁵⁶⁾.

18.3 Redial Mode

You can select whether your phone uses the redial list or last call redial mode.

1. Press the **Features** soft key if shown. To do this during a call, press the  **PHONE** key and then press the **Features** soft key.
2. Use the ▲ up and down ▼ arrow keys to highlight **Call Settings**. Press **Select**.
4. Use the ▲ up and down ▼ arrow keys to highlight **Redial Action**.
5. The current mode, **Open Call Log** or **Last Dialed** is displayed.
 - [Open Call Log](#) ⁽³⁶⁾
If this mode is selected, pressing **Redial** will display a menu of the most recent outgoing calls in your call log. You can select the call that you want to redial and perform a number of other functions.
 - [Last Dialed](#) ⁽³⁶⁾
If this mode is selected, pressing **Redial** will immediately repeat the most recent outgoing call in your call log. None of the other redial functions will be accessible.
6. Press **Change** to change the mode.
7. When the desired mode is displayed, press **Save**.

18.4 En-Bloc Dialing

By default, when you start dialing a number on your phone, the phone immediately connects to the telephone system and starts passing the digits you dial to the phone system. You cannot correct the digits you have already dialed except by ending the call and starting over. Also, if you pause dialing for too long the phone system may think that you have finished dialing and will attempt to connect the call using only the digits you had dialed up to that point.

En-bloc dialing allows you to compose and edit the number to dial on your phone's display before it is sent to the phone system to be dialed.

Through the phone's menus you can select whether you want to use traditional or en-bloc dialing when making calls. Your chosen setting is then applied whenever you use a phone that supports en-bloc dialing.

You can enable or disable your en-bloc dialing setting through the phone's **Features** menu.

1. Press the **Features** soft key if shown. To do this during a call, press the  **PHONE** key and then press the **Features** soft key.
2. Use the ▲ up and down ▼ arrow keys to highlight **Call Settings**. Press **Select**.
4. Use the ▲ up and down ▼ arrow keys to highlight **En-Bloc Dial**.
5. Use **Change** button to select **On** or **Off**.

18.5 Auto Lock

Rather than logging out, you can lock your phone. You can either [lock your phone manually](#)^[84] using the steps below or have it automatically locked after a period of phone inactivity. To use this feature you need a [security PIN](#)^[85] (login code) set.

When your phone is locked:

- It can only be used to make internal and emergency calls.
- None of the menus for your user settings can be accessed.
- [Unlocking the phone](#)^[85] requires your login code, if you have [configured a login code](#)^[85].

1. Press the **Features** soft key if shown. To do this during a call, press the  **PHONE** key and then press the **Features** soft key.
2. Use the ▲ up and down ▼ arrow keys to highlight **Phone User**. Press **Select**.
3. Use the ▲ up and down ▼ arrow keys to highlight **Phone Screen Settings**. Press **Select**.
4. Use the ▲ up and down ▼ arrow keys to highlight **Auto Lock (minutes)**.
5. Press the **Change** soft key to change the setting or use the ◀ left or right ▶ arrow keys.
 - **Disabled**
Do not use the inactivity timer.
 - **1 / 5 / 30 / 60**
Lock the phone after the indicated number of minutes.
6. Press the **Save** soft key.

Access Control

Your system administrator can configure whether you can access this menu option. See [Menu Access Control](#)^[156].

18.6 Ringer Controls

This section covers controls for adjusting the ringing used by your phone.

- [Disabling the ringer](#)^[121]
- [Ring Pattern/Sound](#)^[122]
- [Flash the message lamp for calls \(Visual Alerting\)](#)^[124]
- [Coverage Ring](#)^[124]
- [Ringer Volume](#)^[124]
- [Internal Auto Answer](#)^[124]

18.6.1 Disabling the Ringer

This option can be used to turn off the ringer for all calls. If set to no ring, this disables both the phone's audible alerting and [visual alerting](#)^[124]. On some 9600 Series phones, when you disable the ringer, the status indication line displays a  icon.

1. Press the **Features** soft key if shown. To do this during a call, press the  **PHONE** key and then press the **Features** soft key.
2. Use the ▲ up and down ▼ arrow keys to highlight **Call Settings**. Press **Select**.
3. Use the ▲ up and down ▼ arrow keys to highlight **Disable Ringer**.
4. Press the **Change** soft key to change the setting. Selecting **On** will turn the ringer off.

18.6.2 Ring Pattern/Sound

9600 Series telephones can support two types of ring tones.

Alternate/Rich Ring Tones

Alternate ring tones are supported by 96x0 telephones, rich ring tones are supported on 96x1 phones. With these tones, the telephone uses the same ring for all types of call.

Classic Ring Tones

With classic ring tones, the telephone system uses different ring patterns for different types of call. The ring pattern is a combination of the phone's default ring tone followed by your [personal ring tone selection](#)^[123]. For each call or line appearance button on your telephone, your system administrator can also adjust when ringing is used (immediately, after a small delay or off).

Call Type	Ring (1.2s)		Silence (4.0s)
Internal	Default	Personal ring	Silence
External			
Ringback			
0.1 seconds:			

- Internal Calls:** *Two-tone long ring.*
 This type of ring is used for internal calls.
- External Calls:** *Double ring (one short ring, one normal ring).*
 This type of ring is used for external calls. Note that that also includes internal calls where the caller is transferring an external call.
- Ringback/Return Calls:** *Two very short rings followed by a normal ring.*
 This type of ring is used for calls that are returning to your phone. For example, a call that you put on hold and which is returning due to being left on hold too long.
- Coverage Ring:** *Variable*
 You can also adjust the ringing used for call coverage and bridged appearance buttons. See [Coverage Ring](#)^[124]. The options are normal ringing (internal or external), an abbreviated ring (a non-repeated short ring) or no ring.
- Attention Ring:** *Variable*
 The system administrator can adjust the ring used for new calls when you are already on a call. The options are an abbreviated ring or no ring. For calls alerting on a call coverage or bridged appearance button when you are already on a call, the shorter of the coverage ring or attention ring settings is used.

18.6.2.1 Personal Ring Tone Selection

The telephone system supports 8 different classic ring tones. The selected tone is used for the [personal ring portion of the ring](#) ⁽¹²²⁾.

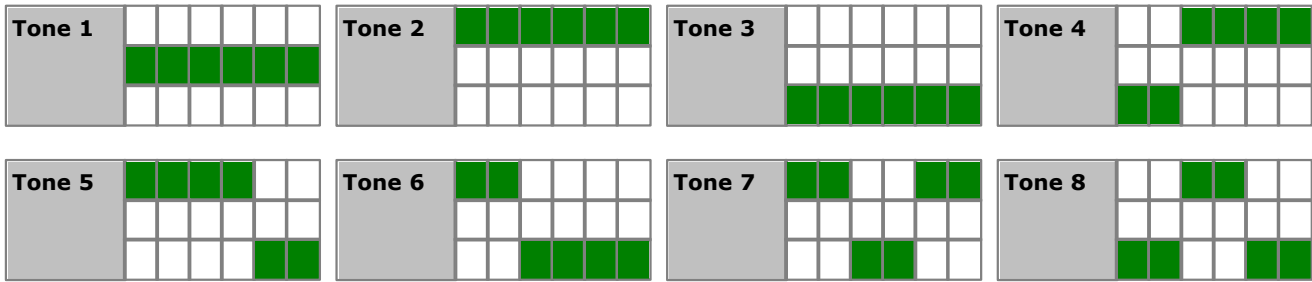

To change your personal ring tone:

1. Press the **A MENU/HOME** button and select **Settings**.
2. Use the **▲** up and down **▼** arrow keys to highlight **Options & Settings**. Press **Select**.
3. Use the **▲** up and down **▼** arrow keys to highlight **Screen & Sound Options**. Press **Select**.
4. Use the **▲** up and down **▼** arrow keys to highlight **Personalized Ringing**. Press **Change**.
 - Use the **▲** up and down **▼** arrow keys to scroll through the different available ring patterns.
- On 96x0 phones, press **Other** to switch between selecting from the classic ring tones or alternate ring tones. On 96x1 phones, you can use the **Classic** or **Rich** buttons to switch between selecting from the different sets of ring tones.
 - To make the currently displayed ring pattern the selected ring pattern for the phone press the **Save** soft key.
 - To leave the menu without making any changes press the **Cancel** soft key.
5. When completed, press the **Back** soft key.
6. Press the **Exit** soft key to exit the menus.

18.6.3 Visual Alerting

The message waiting lamp at the top-right corner of the phone can also be used to indicate when you have a call alerting your phone. The lamp is flashed to indicate a call waiting to be answered.

1. Press the **A MENU/HOME** button and select **Settings**.
2. Use the **▲** up and down **▼** arrow keys to highlight **Options & Settings**. Press **Select**.
3. Use the **▲** up and down **▼** arrow keys to highlight **Call Settings**. Press **Select**.
4. Use the **▲** up and down **▼** arrow keys to highlight **Visual Alerting**.
5. Press the **Change** soft key to change the setting.
6. When completed, press the **Save** soft key.
7. Press the **Back / Exit** soft keys to exit the menus.



18.6.4 Coverage Ring

If you have any bridged appearance and or call coverage buttons, you can [set the type of ringing \(coverage ring\)](#)^[124] that should be used when a call alerts on any of those buttons. The options are to use normal ringing, a single non-repeated ring (abbreviated ring) or no ring. The coverage ring setting is only used if you do not already have a connected call. If you already have a connected call in progress, the shorter of the coverage ring and attention ring settings is used.

This is a user setting which will move with you if you hot desk another phone.

1. Press the **Features** soft key if shown. To do this during a call, press the  **PHONE** key and then press the **Features** soft key.
2. Use the **▲** up and down **▼** arrow keys to highlight **Call Settings**. Press **Select**.
3. Use the **▲** up and down **▼** arrow keys to highlight **Coverage Ring**.
4. Press the **Change** soft key to change the setting.
 - **Ring** - Use normal ringing.
 - **Abbreviated** - Use a single non-repeated ring (abbreviated ring).
 - **Off** - No ring.

18.6.5 Ringer Volume

You can adjust the ringer volume while the phone is idle or while it is ringing. The status indication line displays a  icon followed by eight bubbles that represent the volume level. When no ringer is audible, the indication line displays a  icon.

1. With the phone idle or ringing, press the  key.
2. Use the **+** plus and **-** minus keys to adjust the volume.
3. The display returns to normal after a few seconds.

18.6.6 Internal Auto Answer

You can select to have internal calls automatically connected if you are not already on a call. The call will be connected, after the phone gives a brief tone, using either the phone's speaker or the headset as set by the phone's [audio path setting](#)^[131].

1. Press **Features**.
2. Use the **▲** up and down **▼** arrow keys to highlight **Options & Settings**. Press **Select**.
3. Use the **▲** up and down **▼** arrow keys to highlight **Call Settings**. Press **Select**.
4. Use the **▲** up and down **▼** arrow keys to highlight **Internal Auto-Answer**.
5. Press the **Change** soft key to change the setting.

This function can be assigned to a [feature button](#)^[108] configured with the Internal Auto Answer action. The button lamp will indicate when 'internal auto answer' is on.

Access Control

Your system administrator can configure whether you can access this menu option. See [Menu Access Control](#)^[156].

18.7 Display Controls

This section covers controls for adjusting the phone's display and the information shown on the display.

- [Display Brightness](#) ^[128]
Adjust the brightness of the display.
- [Display Contrast](#) ^[128]
Adjust the contrast of the display.
- [Call Timer](#) ^[128]
Adjust whether the ring/call time is displayed for calls on appearance buttons.
- [Show Last Call Duration](#) ^[128]
Display the duration of a call for a few seconds after the call is ended.
- [Display Language](#) ^[128]
Select the language used for the phone's menus.
- [Auto Display Waiting Call](#) ^[127]
If, when already on a call, there is another call waiting to be answered, automatically display the call information of the waiting call.
- [Exit Menu Inactivity Timer \(Auto Return\)](#) ^[128]
Return to the normal call display after a period of inactivity in a menu.
- [Quick Touch Lines](#) ^[128]
On 9621 and 9641 phones you can display a fixed set of buttons at the bottom of the home screen.

18.7.1 Display Brightness

1. Press the **A MENU/HOME** button and select **Settings**.
2. Use the **▲** up and down **▼** arrow keys to highlight **Options & Settings**. Press **Select**.
3. Use the **▲** up and down **▼** arrow keys to highlight **Screen & Sound Options**. Press **Select**.
4. Use the **▲** up and down **▼** arrow keys to highlight **Brightness**. Press **Select**.
5. Use the **◀** left and right **▶** arrow keys to adjust the brightness as required.
6. When completed, press the **Save** soft key.
7. Press **Back / Exit** to exit the menus.

18.7.2 Display Contrast

1. Press the **A MENU/HOME** button and select **Settings**.
2. Use the **▲** up and down **▼** arrow keys to highlight **Options & Settings**. Press **Select**.
3. Use the **▲** up and down **▼** arrow keys to highlight **Screen & Sound Options**. Press **Select**.
4. Use the **▲** up and down **▼** arrow keys to highlight **Contrast**. Press **Select**.
5. Use the **◀** left and right **▶** arrow keys to adjust the brightness as required.
6. When completed, press the **Done** soft key.
7. Press **Back / Exit** to exit the menus.

18.7.3 Last Call Duration Display

As an alternate to [call timer](#)^[12b] display, you can have the phone briefly (4 seconds) display the duration of the call after it is ended.

1. Press the **Features** soft key if shown. To do this during a call, press the  **PHONE** key and then press the **Features** soft key.
2. Use the ▲ up and down ▼ arrow keys to highlight **Call Settings**. Press **Select**.
3. Use the ▲ up and down ▼ arrow keys to highlight **Show Last Call Duration**.
4. Press **Change** to change the setting between **On** or **Off**.
5. Press the **Save** soft key.

18.7.4 Home Screen Display

The [home screen](#)^[114] used on 9621 and 9641 phones can be set to automatically display if the phone is idle for over 10 minutes.

1. Press the  **MENU/HOME** button and select **Settings**.
2. Use the ▲ up and down ▼ arrow keys to highlight **Options & Settings**. Press **Select**.
3. Use the ▲ up and down ▼ arrow keys to highlight **Screen & Sound Options**. Press **Select**.
4. Select **Return to Home Screen** to change the current setting for that function.
5. Press **Save**.

18.7.5 Call Timer Display

When you have calls alerting on appearance buttons, the phone can include a timer in the appearance details shown on the display. The timer shows how long the call has been alerting and, if you answer the call, resets to show how long the call has been connected. The timer will also show how long a call has been on hold when you hold the call.

You can turn the timer display on or off. Turning it off provides more space for other call details on the display.

9621 and 9641 Phones

By default, when you are connected on a call, the display will show details of that call. In order to see details of a another call, such as a held call or a waiting call, you need to scroll the display using the up and down arrow buttons.

Using this option, you can select to have the current call display automatically toggle between details of the current call and details of the waiting call.

1. Press the **Features** soft key if shown. To do this during a call, press the  **PHONE** key and then press the **Features** soft key.
2. Use the ▲ up and down ▼ arrow keys to highlight **Call Settings**. Press **Select**.
3. Use the ▲ up and down ▼ arrow keys to highlight **Call Timer**.
4. Press **Change** to change the setting between **On** or **Off**.
5. Press the **Save** soft key.

Other 9600 Phones

1. Press the  **MENU/HOME** button and select **Settings**.
2. Use the ▲ up and down ▼ arrow keys to highlight **Options & Settings**. Press **Select**.
3. Use the ▲ up and down ▼ arrow keys to highlight **Call Settings**. Press **Select**.
4. Use the ▲ up and down ▼ arrow keys to highlight **Display Call Timer**.
5. Press **Change** to change the setting between **On** or **Off**.
6. When completed, press the **Save** soft key.
7. Press **Back / Exit** to exit the menus.

18.7.6 Display Language

The system administrator can configure which languages are available for use by the phone for its own menus. Up to five languages can be made available.

Through the phone's menu you can select which of those languages the phone should use.

Note that many of the messages displayed on the phone use text sent from the telephone system. They will use the default language of the telephone system unless the system administrator has set your extension to use a specific language supported by the phone system.

1. Press the **A MENU/HOME** button and select **Settings**.
2. Use the **▲** up and down **▼** arrow keys to highlight **Options & Settings**. Press **Select**.
3. Use the **▲** up and down **▼** arrow keys to highlight **Screen & Sound Options**. Press **Select**.
4. Use the **▲** up and down **▼** arrow keys to highlight **Language**. Press **Select**.
5. Use the **▲** up and down **▼** arrow keys scroll through the different languages available.
6. To select the language currently highlighted, press **Select**.
7. When completed, press the **Save** soft key.
8. Press **Back / Exit** to exit the menus.

18.7.7 Auto Display Waiting Call

By default, when you are connected on a call, the phone shows details of that call and soft key actions you can perform for that call. In order to see details of a waiting call, you need to scroll the display using the up and down arrow buttons.

You can opt to have the phone automatically show details of a waiting call when one alerts the phone and soft key actions that you can perform on the waiting call. If you use the scroll keys to return the display focus to the currently connected call, the focus automatically returns to the waiting call after a few seconds.

1. Press the **Features** soft key if shown. To do this during a call, press the  **PHONE** key and then press the **Features** soft key.
2. Use the **▲** up and down **▼** arrow keys to highlight **Call Settings**. Press **Select**.
4. Use the **▲** up and down **▼** arrow keys to highlight **Auto Display Waiting Call**.
5. Press **Change** to change the setting.
6. Select one of the following settings as desired:
 - **Off** - Show details of the current call only.
 - **On** - Automatically show the details of a waiting call.
7. Press the **Save** soft key.

18.7.8 Inactivity Timer (Auto Return)

You can set a timer which will return the phone to its normal call display after a set period of phone inactivity. By default the phone will be set to auto return after 60 seconds.

Note that the timer is not applied to all menus. For example it is not applied to the A-menu and to the **Visual Voice** menu. It is also not applied to the **System Admin** section of the **Features** menus.

1. Press the **Features** soft key if shown. To do this during a call, press the  **PHONE** key and then press the **Features** soft key.
2. Use the ▲ up and down ▼ arrow keys to highlight **Phone User**. Press **Select**.
3. Use the ▲ up and down ▼ arrow keys to highlight **Phone Screen Settings**. Press **Select**.
4. Use the ▲ up and down ▼ arrow keys to scroll the display to **Auto Return(s)**.
5. Press **Change** to change the setting.
 - **Disabled**
Do not use the inactivity timer.
 - **30 / 60**
Apply the inactivity timer after the selected number of seconds.
6. Press the **Save** soft key.

18.7.9 Quick Touch Lines

For 9621 and 9641 phones, the phone can display one or two rows of fixed buttons across the bottom of the call display screen, each row containing four buttons. 'Fixed' means the rows do not scroll out of view when the rest of the screen is scrolled.

Your system administrator can select how many lines the phone shows by default. However, you can then select the number that you prefer or to have no lines.

Note: Only users with 'self administer' privileges can configure quick touch line buttons.

Quick touch line buttons match the [programmable feature buttons](#)^[108] supported by the telephone system, but certain features can only be configured by an administrator. The available user-programmable features include:

- Abbreviated Dial
- Call Pickup Any
- Absence Text
- Page
- Call Forward All
- Self Administer
- Call Pickup
- Send All Calls

If you attempt to configure a quick touch line button to a feature not supported by the telephone system, the display for that button will read "Invalid." The assigned quick touch features are displayed left to right, top to bottom.

To activate quick touch lines:

1. Press the **Features** soft key if shown. To do this during a call, press the  **PHONE** key and then press the **Features** soft key.
2. Use the ▲ up and down ▼ arrow keys to highlight **Phone User**. Press **Select**.
3. Use the ▲ up and down ▼ arrow keys to highlight **Phone Screen Settings**. Press **Select**.
4. Use the ▲ up and down ▼ arrow keys to scroll the display to the option **Quick Touch Lines**.
5. Press **Change** to change the setting.
 - **Off** = No quick touch rows.
 - **1** = Display one row of four quick touch buttons across the bottom.
 - **2** = Display two rows of four quick touch buttons across the bottom.
 - **Auto** = Display 1 row when using a 9621, 2 rows when using a 9641.
6. Press the **Save** soft key.

To configure a quick touch line button:

2. Press the **Features** soft key if shown. To do this during a call, press the  **PHONE** key and then press the **Features** soft key.
3. Use the ▲ up and down ▼ arrow keys to highlight **Phone User**. Press **Select**.
3. Use the ▲ up and down ▼ keys to highlight **Self Administer**. Press **Select**.

4. Enter your security PIN and press **Done**.
5. On 9621 and 9641 phones, select **Button Features**. Use the ▲ up and down ▼ arrow keys to scroll through the list of current functions assigned to each button.
 - To remove the existing function from a button press **Erase**.
 - You can also press **More** and use the **Copy** and **Paste** options to copy the settings of an existing button to another button.
 - To assign a function to the highlighted button press **Replace**.
 - Select the required function from the list and press **Select**.
 - Depending on the function, you may need to enter some information such as a target extension number.
 - The button will be given a default label. To change the label, press **More** and then select **Label**. Use the keyboard to enter the text you want to display for the button label. Note that the label is only shown while editing the label and after you exit the administration menu.
7. When completed press **Back**.

18.8 Volume and Sound

This section covers controls that relate to volume and to the various sounds that your phone uses. These are in addition to the available [ringer controls](#)^[12†].

- **Button Click**^[130†]
Turn the phone menu key click on or off.
- **Error Tones**^[130†]
Turn the phone menu error tones on or off.
- **Ringer Volume**^[130†]
Adjust the volume of the ringer used by the phone.
- **Handset Volume**^[131†]
Adjust the incoming call volume heard through the phone's handset.
- **Headset Volume**^[131†]
Adjust the incoming call volume heard through a headset attached to the phone.
- **Speaker Volume**^[131†]
Adjust the incoming call volume heard through the phone's speaker.
- **Automatic Gain Control**
Switch automatic gain control on or off.

Note: The system administrator can configure your phone to reset its volume after each call.

18.8.1 Button Clicks



While using the phone menus, the phone can provide a key press confirmation click sound. This can be disabled.

1. Press the **A MENU/HOME** button and select **Settings**.
2. Use the **▲** up and down **▼** arrow keys to highlight **Options & Settings**. Press **Select**.
3. Use the **▲** up and down **▼** arrow keys to highlight **Screen & Sound Options**. Press **Select**.
4. Use the **▲** up and down **▼** arrow keys to highlight **Button Clicks**.
5. Press **Change** to change the setting between **On** or **Off**.
6. When completed, press the **Save** soft key.
7. Press **Back / Exit** to exit the menus.

18.8.2 Error Tones

1. Press the **A MENU/HOME** button and select **Settings**.
2. Use the **▲** up and down **▼** arrow keys to highlight **Options & Settings**. Press **Select**.
3. Use the **▲** up and down **▼** arrow keys to highlight **Screen & Sound Options**. Press **Select**.
4. Use the **▲** up and down **▼** arrow keys to highlight **Error Tones**.
5. Press **Change** to change the setting between **On** or **Off**.
6. When completed, press the **Save** soft key.
7. Press **Back / Exit** to exit the menus.

18.8.3 Ringer Volume

You can adjust the ringer volume while the phone is idle or while it is ringing. The status indication line displays a  icon followed by eight bubbles that represent the volume level. When no ringer is audible, the indication line displays a  icon.

1. With the phone idle or ringing, press the **▲** key.
2. Use the **+** plus and **-** minus keys to adjust the volume.
3. The display returns to normal after a few seconds.

18.8.4 Handset Volume

While talking via the handset, you can adjust the volume of the incoming call. The status indication line displays a  icon followed by eight bubbles that represent the volume level.

1. With the call connected on the handset, press the  key.
2. Use the **+** plus and **-** minus keys to adjust the volume.
3. The display returns to normal after a few seconds.

18.8.5 Headset Volume

While talking via the headset, you can adjust the volume of the incoming call. The status indication line displays a  icon followed by eight bubbles that represent the volume level.

1. With the call connected on the headset, press the  key.
2. Use the **+** plus and **-** minus keys to adjust the volume.
3. The display returns to normal after a few seconds.







18.8.6 Speaker Volume

While talking handsfree via the phone's speaker, you can adjust the volume of the incoming call. The status indication line will display a  icon followed by eight bubbles that represent the volume level.

1. With the call connected on the speaker, press the  key.
2. Use the **+** plus and **-** minus keys to adjust the volume.
3. The display returns to normal after a few seconds.

18.8.7 Automatic Gain Control







When using automatic gain control (AGC), the phone tries to maintain a constant audio level even if the incoming call changes between loud and quiet.

1. Press the  **MENU/HOME** button and select **Settings**.
2. Use the  up and down  arrow keys to highlight **Advanced Options**. Press **Select**.
3. Use the  up and down  arrow keys to highlight **Automatic Gain Control**. Press **Select**.
 - Use the  up and down  arrow keys to switch between **Handset**, **Headset**, or **Speaker** settings for AGC.
 - To change the highlighted setting, press **Change**.
4. When completed, press **Save**.
5. Press **Back / Exit** to exit the menus.

18.8.8 Default Handsfree Audio Path

By default, when you make a call or answer a call without lifting the handset, the audio is played through the phone's speaker while you speak via the phone's microphone.

If you have a headset attached, you can change the phone's behavior so that the audio is played through the headset by default rather than the speaker.

1. Press the  **MENU/HOME** button and select **Settings**.
2. Use the  up and down  arrow keys to highlight **Options & Settings**. Press **Select**.
3. Use the  up and down  arrow keys to highlight **Call Settings**. Press **Select**.
4. Use the  up and down  arrow keys to highlight **Audio Path**.
5. Press **Change** to change the setting between **Headset** and **Speaker**.
6. When completed, press the **Save** soft key.
7. Press the **Back / Exit** soft keys to exit the menus.

18.9 Backup/Restore

If backup/restore has been setup by your system administrator, it is used automatically when you log in and log out of the phone.

Backup/restore is used for the phone settings that you have configured within the menus provided by the phone's **A MENU/HOME** button. When you log in at another 1600 or 9600 Series phone extension, your phone settings are restored and applied to that phone. They will remain applied to that phone until another user logs in and their phone settings are applied.

By default, your call log and your personal contacts are stored on the telephone system. These will be restored by the telephone system when you log in on another 1600 or 9600 Series phone regardless of whether backup/restore has been configured for the 1600 and 9600 Series phones.

When backup/restore has been configured, the phone menu provides options to manually access backup and restore functions.

- [Manually Backup Phone Settings](#)^[132]
- [Manually Restore Phone Settings](#)^[132]

18.9.1 Backup

If backup/restore has been setup by your system administrator, it is used automatically when you log in and log out of the phone.

In addition, the option below is available to manually trigger a backup of your user settings.

1. Press the **A MENU/HOME** button and select **Settings**.
 2. Use the **▲** up and down **▼** arrow keys to highlight **Advanced Options**. Press **Select**.
 3. Use the **▲** up and down **▼** arrow keys to highlight **Backup/Restore**. Press **Change**.
 4. Use the **▲** up and down **▼** arrow keys to highlight **Manual Backup**. Press **Backup**.
- **!** This option is only available if your system administrator has configured backup/restore operation.

18.9.2 Restore

If backup/restore has been setup by your system administrator, it is used automatically when you log in and log out of the phone.

In addition, the option below is available to manually trigger a restore of your user settings.

1. Press the **A MENU/HOME** button and select **Settings**.
 2. Use the **▲** up and down **▼** arrow keys to highlight **Advanced Options**. Press **Select**.
 3. Use the **▲** up and down **▼** arrow keys to highlight **Backup/Restore**. Press **Change**.
 4. Use the **▲** up and down **▼** arrow keys to highlight **Manual Restore**. Press **Restore**.
- **!** This option is only available if your system administrator has configured backup/restore operation.

18.10 Viewing Information

You can view information about the phone's settings and current operation. When reporting a problem to your system administrator, they may ask you to provide some of this information to help resolve the problem.

1. Press the **A MENU/HOME** button and select **Settings**.
2. Use the **▲** up and down **▼** arrow keys to highlight **Network Info....** Press **Select**.
3. Use the **◀** left and right **▶** arrow keys to move through the different pages of information.
 - **Audio Parameters**
The settings configured for sound and sound devices.
 - **IP Parameters**
The IP settings with which the phone has been configured by the installer or by a DHCP server.
 - **Quality of Service**
Quality of Service (QoS) measurements for the current call.
 - **Interfaces**
The current speed of the phone's ethernet port and its PC pass-through Ethernet port.
 - **Miscellaneous**
Details of the phone and the firmware that it currently has loaded.
4. To return to the parent menu, press the **Back** soft key.

Chapter 19.

Status Menu

19. Status Menu

The **Status** menu is not always visible. It is shown when you have any special call routing features active; for example, 'do not disturb' switched on.

It is also shown if the system administrator has given you the rights to change the status of your hunt group memberships or to change the service status of the hunt groups.

- [Switching mobile twinning off](#) ^[139]
- [View and unpark parked calls](#) ^[140]
- [Clear or change a 'follow me to' setting](#) ^[136]
- [Switch off 'do not disturb'](#) ^[136]
- [Clear or change 'forward unconditional'](#) ^[138]
- [Clear or change 'forward on no answer'](#) ^[138]
- [Clear or change 'forward on busy'](#) ^[137]
- [Clear or change 'follow me here' settings](#) ^[137]
- [Change hunt group membership status](#) ^[139]
- [Change hunt group service status](#) ^[139]
- [View system alarms](#) ^[140]

19.1 Do Not Disturb

You can use the **Status** menu to switch off 'do not disturb.'

1. Press the **Status** soft key if shown.
 - To access the Status menu during a call, press the  **PHONE** key and then press the **Status** soft key if shown.
2. If necessary use the ▲ up and down ▼ arrow keys to highlight **Do Not Disturb**.
 - To clear the 'do not disturb' setting, press the **Off** soft key.

Access Control

Your system administrator can configure whether you can access this menu option. See [Menu Access Control](#) ^[156].

19.2 Follow Me To

If you have set a 'follow me to' destination for calls to your phone, you can clear or change the setting through the **Status** menu.

1. Press the **Status** soft key if shown.
 - To access the Status menu during a call, press the  **PHONE** key and then press the **Status** soft key if shown.
2. Use the ▲ up and down ▼ arrow keys to highlight **Follow Me To**.
 - To clear the 'follow me to' setting, press the **Clear** soft key.
 - To change the destination of the setting, press the **Details** soft key.

Access Control

Your system administrator can configure whether you can access this menu option. See [Menu Access Control](#) ^[156].

19.3 Follow Me Here

If other users has a 'follow me' set to you phone, you can clear or change the setting through the **Status** menu.

1. Press the **Status** soft key if shown.
 - To access the Status menu during a call, press the  **PHONE** key and then press the **Status** soft key if shown.
2. Use the ▲ up and down ▼ arrow keys to highlight **Follow Me Here**. There will be a separate entry for each user.
 - To clear the 'follow me to' setting, press the **Clear** soft key.
 - To change the destination of the setting, press the **Details** soft key.
 - Use the menu to add or remove users.
 - Use the ▲ up and down ▼ arrow keys to scroll through the names.
 - To remove a user, press the **Clear** soft key.
 - To add a user, press the **Add** soft key.
 - Dial the number of another user. When it matches a user, their name is displayed. Alternatively, use the **Dir** soft key to [select a user from the directory](#)^[64].
 - Press the **Save** soft key to set the 'follow me here.'

Access Control

Your system administrator can configure whether you can access this menu option. See [Menu Access Control](#)^[156].

19.4 Forward On Busy

If your phone is set to 'forward on busy,' you can clear or change the forward settings through the **Status** menu.

1. Press the **Status** soft key if shown.
 - To access the Status menu during a call, press the  **PHONE** key and then press the **Status** soft key if shown.
2. Use the ▲ up and down ▼ arrow keys to highlight **Fwd Busy**.
3. To switch the forward off press **Off**.
4. To change the forward setting press **Details**.
 - Use the ▲ up and down ▼ arrow keys to scroll through the menu options.
 - To switch 'forward on busy' on or off, highlight **Fwd Busy** and press **On** or **Off**.
 - To switch 'forward on no answer' on or off, highlight **Fwd No Answer** and press **On** or **Off**.
 - To select which calls are forwarded highlight **Call Type**. Press **Change** to change the option between **All Calls** or **External Calls Only**.
 - To change the destination highlight **Destination** and press **Edit**. Enter the number and press **Select**.
 - Press **Save** to save any changes.

Access Control

Your system administrator can configure whether you can access this menu option. See [Menu Access Control](#)^[156].

19.5 Forward On No Answer

If your phone is set to [forward on no answer](#)^[163] you can clear or change the forward settings through the **Status** menu.

1. Press the **Status** soft key if shown.
 - To access the Status menu during a call, press the  **PHONE** key and then press the **Status** soft key if shown.
2. Use the ▲ up and down ▼ arrow keys to highlight **Fwd No Answer**.
3. To switch the forward off press **Off**.
4. To change the forward setting press **Details**.
 - Use the ▲ up and down ▼ arrow keys to scroll through the menu options.
 - To switch 'forward on busy' on or off, highlight **Fwd Busy** and press **On** or **Off**.
 - To switch 'forward on no answer' on or off, highlight **Fwd No Answer** and press **On** or **Off**.
 - To select which calls are forwarded highlight **Call Type**. Press **Change** to change the option between **All Calls** or **External Calls Only**.
 - To change the destination highlight **Destination** and press **Edit**. Enter the number and press **Select**.
 - Press **Save** to save any changes.

Access Control

Your system administrator can configure whether you can access this menu option. See [Menu Access Control](#)^[156].

19.6 Forward Unconditional

You can clear or change your 'forward unconditional' settings through the **Status** menu.

1. Press the **Status** soft key if shown.
 - To access the Status menu during a call, press the  **PHONE** key and then press the **Status** soft key if shown.
2. Use the ▲ up and down ▼ arrow keys to highlight **Fwd Uncon**.
 - To switch off 'forward unconditional,' press the **Off** soft key.
 - To change the forwarding settings, press the **Details** soft key.
 - Use the ▲ up and down ▼ arrow keys to scroll through the editing options.
 - Use the ◀ left and right ▶ arrow keys to switch the forwarding on or off.
 - Use the ◀ left and right ▶ arrow keys to select which calls should be forwarded. The options are **External Only**, **External and Group**, **Non Group Calls**, and **All Calls**.
 - Select edit to change the number to which calls are forwarded.

Access Control

Your system administrator can configure whether you can access this menu option. See [Menu Access Control](#)^[156].

19.7 Forwarded Here

This option allows you to see the names of users who are currently forwarding calls to you. It includes 'forward unconditional,' 'forward on no answer,' and 'forward on busy.' A separate entry is shown for each user.



1. Press the **Status** soft key if shown.
 - To access the Status menu during a call, press the  **PHONE** key and then press the **Status** soft key if shown.
2. Use the ▲ up and down ▼ arrow keys to highlight **Fwd To Here**.

Access Control

Your system administrator can configure whether you can access this menu option. See [Menu Access Control](#)^[156].



19.8 Group Membership

Your system administrator can grant you the ability to enable/disable your membership to a group through the **Status** menu. When your membership to a group is disabled, you do not receive group calls for that group.

1. Press the **Status** soft key if shown.
 - To access the Status menu during a call, press the  **PHONE** key and then press the **Status** soft key if shown.
2. Use the  up and down  arrow keys to highlight the hunt group name and your current membership status (**Enabled** or **Disabled**).
3. Press the **Enable** or **Disable** soft key to change the status of your membership to that group.
4. Press **Exit**.



19.9 Group Service Status

If the system administrator has allowed you, you can change the service state of a group through the **Status** menu.

1. Press the **Status** soft key if shown.
 - To access the Status menu during a call, press the  **PHONE** key and then press the **Status** soft key if shown.
2. Use the  up and down  arrow keys to highlight the hunt group name and your current membership status.
3. Select the required state using the soft keys:
 - **In Service (InS)**
The groups operates as normal, distributing calls to available members of the group.
 - **Night Service (NS)**
The group is in 'night service' mode. Calls are redirected to its night service fallback destination [if set](#)^[106], otherwise to voicemail if available. A hunt group can also be put into and out of night service automatically by the telephone system using a time profile.
 - **Out of Service OOS**
The group is out of service. Calls are redirected to its out of service fallback destination [if set](#)^[106], otherwise to voicemail if available. The phone displays an **O** when one of the groups of which you are a member is out of service. See [Status Letters](#)^[22].
 - **Time Profile (TP)**
This setting indicates that the group's status is being controlled by a time profile on the telephone system. That time profile sets when the group is in service and in night service. You can override this to put the group into the **Out of Service** state. You can then use the phone to returns the group to time profile control when required.
- **!** The system administrator is able to configure whether you have access to the **Membership, State** and **Fallback** options of a group. If you are not configured for any groups then the **Group** menu is not shown.

19.10 Mobile Twinning

If you have been configured as a mobile twinning user, you can use the status menu to switch mobile twinning mode off.

1. Press the **Status** soft key if shown.
 - To access the Status menu during a call, press the  **PHONE** key and then press the **Status** soft key if shown.
2. If necessary use the  up and down  arrow keys to highlight **Mobile Twinning**.
 - To clear the setting, press the **Off** soft key.

19.11 Parked Calls

While parked calls are parked on the telephone system and can be unparked by any other user, the parked call indication is sent to a particular extension. If there are any calls parked against your phone, you can view and unpark them via the **Status** menu.

1. Press the **Status** soft key if shown.
 - To access the Status menu during a call, press the  **PHONE** key and then press the **Status** soft key if shown.
2. If you have any parked calls, the **Parks** option is displayed. The option is not present if you do not have calls parked against your extension.
3. Press the **Details** soft key.
4. Use the ▲ up and down ▼ arrow keys to scroll through the parked calls.
5. To unpark a particular call, press the **Connect** soft key.

Access Control

Your system administrator can configure whether you can access this menu option. See [Menu Access Control](#)^[156].

19.12 System Alarms

An **S** appearing in the [phone status letters](#)^[22] on the display indicates that a system alarm has occurred. This happens if you are configured as a system administrator (also called a system phone user).

A corresponding alarm message appears in the phone's **Status** menu. This allows you to report the problem to your system maintainer.

You can clear some alarms from the phone. When that is the case, the alarm message includes a **Clear** option. The System Status application can clear all alarms. Note however that the alarm will reoccur if the system maintainer has not resolved the original cause.

Some of the possible alarm messages are:

- **Alarm Log Entry**
This indicates that a system alarm has been recorded in the telephone system's alarm log. These can only be cleared using the System Status application.
- **Corrupt Date/Time**
There is an error in the date or time being used by the system. Selecting **Admin** takes you to the system administration menu where see the system's [date](#)^[146] and [time](#)^[146] settings.
- **Expansion Failure**
There is a problem with one of the external expansion modules attached to the telephone system.
- **Memory Card Failure**
There is a problem with one of the memory cards used by the telephone system. Selecting **Admin** takes you to the system administration menu where you can check the [status of the memory cards](#)^[156].
- **Licence Key Failure**
There is a problem with the memory card used to license features and applications.
- **System Boot Error**
The telephone system encountered an error while restarting.
- **Voicemail Failure**
The voicemail system is not available.
- **Voicemail Almost Full**
The voicemail system is nearly out of storage space for any more messages, prompts and recordings.
- **Voicemail Full**
The voicemail system cannot store any more messages, prompts and recordings.

Chapter 20.

Short Codes

20. Short Codes

Short codes are numbers that you can dial to enable and disable various features. The following are default short codes that may be available. However, your system administrator can remove and change the short codes available to you or all users.

These are useful as they can be dialed from any phone on the system. For example, this allows you to login at a basic analog extension and still control a number of features.

Some short codes require you to enter some information when you dial them, typically an extension number. That is indicated by **N** in the short codes shown below.

Park/Unpark

- **Park Call: *37*N#**
Parks the held call using the park number dialed in place of **N**.
- **Unpark Call: *38*N#**
Unpark the call parked using the park number **N**.

Call Pickup

- **Pickup Any Call: *30**
Answer a call ringing on the telephone system.
- **Pickup a Group Call: *31**
Answer a call ringing a group of which you are a member. You can use this even if your group membership is currently set to disabled.
- **Pickup a Users Call: *32*N#**
Pickup a call ringing a user's extension number (**N**).
- **Pickup a Group Members Call: *53*N#**
Pickup a call ringing the members of a group (**N**). This does not necessarily have to be a group call.

Conference

- **Conference Held Calls: *47**
Start a conference between yourself and any calls that you have on hold.

Do Not Disturb

- **Switch Do Not Disturb On: *08**
Set your phone to 'do not disturb.'
- **Switch Do Not Disturb Off: *09**
Switch off 'do not disturb.'
- **Add a Do Not Disturb Exception Number: *10*N#**
Add a number (**N**) to your list of 'do not disturb' exceptions.
- **Delete a Do Not Disturb Exception Number: *11*N#**
Remove a number (**N**) from your list of 'do not disturb' exceptions.
- **Cancel All Forwarding: *00**
Switch off any forwarding (includes 'forward unconditional,' 'forward on busy,' 'forward on no answer,' 'follow me,' and 'do not disturb').

Follow Me

- **Follow Me Here: *12*N#**
Dialed at the extension to which you want your calls redirected. Use your own extension number (**N**) when dialing the short code.
- **Follow Me Here Cancel: *13*N#**
Dialed at the extension from which you had redirected calls. Use your own extension number (**N**) when dialing the short code.
- **Follow Me To: *14*N#**
Dialed at your phone. Dial the extension number (**N**) to which you want your calls redirected. You can dial just ***14#** to cancel follow me.
- **Cancel All Forwarding: *00**
Switch off any forwarding (includes 'forward unconditional,' 'forward on busy,' 'forward on no answer,' 'follow me,' and 'do not disturb').

Forwarding

- **Cancel All Forwarding: *00**
Switch off any forwarding (includes 'forward unconditional,' 'forward on busy,' 'forward on no answer,' 'follow me,' and 'do not disturb').
- **Set the Forward Unconditional Destination: *07*N#**
Set the destination number (**N**) for 'forward unconditional' when it is switched on.
 - **Switch Forward Unconditional On: *01**
Switch on 'forward unconditional.' A destination must have been set.
 - **Switch Forward Unconditional Off: *02**
 - **Include Hunt Group Calls in Forward Unconditional: *50**
 - **Exclude Hunt Group Calls from Forward Unconditional: *51**
- **Set the Forward On Busy/No Answer Destination: *57*N#**
Set the destination number (**N**) for 'forward on busy' and 'forward on no answer.' If no number has been set, those functions will use the 'forward unconditional' number if set.
 - **Switch Forward On Busy On: *03**
 - **Switch Forward On Busy Off: *04**
 - **Switch Forward on No Answer On: *05**
 - **Switch Forward on No Answer Off: *06**

Hunt Group

- **Night Service Status On: *20*N#**
Set a hunt group into night service status by entering its extension number (**N**).
- **Night Service Status Off: *21*N#**
Take a hunt group out of night service status by entering its extension number (**N**).

Login

- **Log In: *35*N*P#**
Log in to a phone using your extension number (**N**) and login code (**P**).
- **Log Out: *36**
Log yourself out from the phone where you are currently logged in.

Voicemail

- **Check Messages: *17**
Access mailboxes to check for messages.
- **Voicemail On: *18**
Allow voicemail to be used to answer calls.
- **Voicemail Off: *19**
Stop voicemail being used to answer calls.
- **Voicemail Ringback On: *48**
Have voicemail ring your phone when you have any new messages. It will call when you use the phone.
- **Voicemail Ringback Off: *49**
Switch off ringback.

Chapter 21.

System Administration

21. System Administration

If necessary, the system administrator can configure you as a 'system phone' user. This allows you to perform a range of additional functions to help maintain your phone system, such as:

- [Checking the system and software version](#) ^[146]
- [Checking the time settings](#) ^[147]
- [Setting the date](#) ^[148]
- [Setting the time](#) ^[148]
- [Setting the time offset](#) ^[148]
- [System shutdown](#) ^[149]
- [Memory card/file system management](#) ^[150]
- [System alarms](#) ^[151]

21.1 Checking the System Information

Being able to check and report the system software version may be useful when reporting any potential problems to the system administrator.

1. Press the **Features** soft key if shown. To do this during a call, press the  **PHONE** key and then press the **Features** soft key.
2. Use the ▲ up and down ▼ arrow keys to highlight **Phone User**. Press **Select**.
3. Use the ▲ up and down ▼ arrow keys to highlight **System Administration**. Press **Select**. If the option is not present then you may not have been configured as a system phone user by your system administrator.
4. Enter your security PIN (login code) and press **Done**.
5. Use the ▲ up and down ▼ arrow keys to highlight **System Information**. Press **Select**.
6. The system displays the following information about itself:
 - The system type and the level of software it is running.
 - The IP addresses of the two network interfaces.
 - The serial number of the license key.

21.2 Setting the Date

The process below can be used when the telephone system does not obtain the time and date automatically. On systems that are configured to obtain the time automatically, the option for checking the [Time Server Status](#) ^[147] is available instead.

1. Press the **Features** soft key if shown. To do this during a call, press the  **PHONE** key and then press the **Features** soft key.
2. Use the ▲ up and down ▼ arrow keys to highlight **Phone User**. Press **Select**.
3. Use the ▲ up and down ▼ arrow keys to highlight **System Administration**. Press **Select**. If the option is not present then you may not have been configured as a system phone user by your system administrator.
4. Enter your security PIN (login code) and press **Done**.
5. Use the ▲ up and down ▼ arrow keys to highlight **Date**. Press **Select**.
6. The current date being used by the telephone system is displayed.
7. Enter the required date, using the either the * or # keys to enter the / separators. To delete the previous digit or character entered press **Bksp**.
8. When a complete valid date has been entered, the display will confirm that by showing the full date and the **Set** soft key option.
9. To set the date as the new date to be used by the telephone system press **Set**.

21.3 Checking the Time Server Status

For systems that automatically obtain the time from a time server, this option is available in place of the [Date](#)^[14b], [Time](#)^[14b] and [Time Offset](#)^[14b] functions. It allows you to check the current status of the time server and the information the system has obtained from the time server.

- **Time Display Format**

The time format (12 or 24-hour) is controlled by the telephone system. It can be set to either 12-hour or 24-hour format for all phones by the system administrator.

1. Press the **Features** soft key if shown. To do this during a call, press the  **PHONE** key and then press the **Features** soft key.
2. Use the ▲ up and down ▼ arrow keys to highlight **Phone User**. Press **Select**.
3. Use the ▲ up and down ▼ arrow keys to highlight **System Administration**. Press **Select**. If the option is not present then you may not have been configured as a system phone user by your system administrator.
4. Enter your security PIN (login code) and press **Done**.
5. Use the ▲ up and down ▼ arrow keys to highlight **Time Server Status**. Press **Select**.
6. The time server information is listed. It includes the address of the time server, the current local time and the UTC time. If the phone system is configured for daylight savings then the current amount of daylight savings being applied to the local time is also shown.

21.4 Setting the Time

The process below can be used when the telephone system does not obtain the time and date automatically. On systems that are configured to obtain the time automatically, the option for checking the [Time Server Status](#)^[14] is available instead.

- **Time Display Format**

The time format (12 or 24-hour) is controlled by the telephone system. It can be set to either 12-hour or 24-hour format for all phones by the system administrator.

1. Press the **Features** soft key if shown. To do this during a call, press the  **PHONE** key and then press the **Features** soft key.
2. Use the ▲ up and down ▼ arrow keys to highlight **Phone User**. Press **Select**.
3. Use the ▲ up and down ▼ arrow keys to highlight **System Administration**. Press **Select**. If the option is not present then you may not have been configured as a system phone user by your system administrator.
4. Enter your security PIN (login code) and press **Done**.
5. Use the up and down arrow keys to highlight **Time**. Press **Select**.
6. The current time being used by the telephone system is displayed.
7. Enter the required time in 24-hour clock format:
 - Use either the * or # keys to enter the : separator.
 - To delete the previous digit or character entered press **Bksp**.
8. When a complete and valid time has been entered, the display will request confirmation by showing the **Set** soft key option.
9. To set the time as the new time to be used by the telephone system press the **Set** soft key.

21.5 Setting the Time Offset

The process below can be used when the telephone system does not obtain the time and date automatically. On systems that are configured to obtain the time automatically, the option for checking the [Time Server Status](#)^[14] is available instead.

1. Press the **Features** soft key if shown. To do this during a call, press the  **PHONE** key and then press the **Features** soft key.
2. Use the ▲ up and down ▼ arrow keys to highlight **Phone User**. Press **Select**.
3. Use the ▲ up and down ▼ arrow keys to highlight **System Administration**. Press **Select**. If the option is not present then you may not have been configured as a system phone user by your system administrator.
4. Enter your security PIN (login code) and press **Done**.
5. Use the up and down arrow keys to highlight **Local Time Offset**. Press **Select**.
6. The current offset is displayed.
7. Enter the offset required in hours and minutes:
 - To enter the : separator press either the * or # key.
 - To delete the previous digit or character entered press the **Bksp** key.
 - To change the offset from between positive or negative press the ► right arrow key.
8. When a valid offset has been entered, the **Set** soft key is displayed.
9. To apply the offset to the current telephone system time press the **Set** soft key.

21.6 Shutting Down the System

You can shutdown the telephone system for a specified number of minutes. Note that this is not a polite shut-down, once you have confirmed the action, any existing calls and services using the telephone system will start being disconnected. The telephone system will then remain unavailable for the duration you specify, the default being 10 minutes. After the shutdown duration it will take up to 5 more minutes for the telephone system to complete its restart.

! WARNINGS

- A shutdown must always be used to switch off the system. Simply removing the power cord or switching off the power input may cause errors.
- This is not a polite shutdown, any users calls and services in operation will be stopped. Once shutdown, the system cannot be used to make or receive any calls until restarted.
- The shutdown process takes up to a minute to complete. When shutdown, the CPU LED and the base card LEDs 1 and 9 (if trunk daughter card fitted) will flash red rapidly. The memory card LEDs are extinguished. Do not remove power from the system or remove any of the memory cards until the system is in this state.
- To restart a system when shutdown indefinitely, or to restart a system before the timed restart, switch power to the system off and on again.

1. Press the **Features** soft key if shown. To do this during a call, press the  **PHONE** key and then press the **Features** soft key.
2. Use the ▲ up and down ▼ arrow keys to highlight **Phone User**. Press **Select**.
3. Use the ▲ up and down ▼ arrow keys to highlight **System Administration**. Press **Select**. If the option is not present then you may not have been configured as a system phone user by your system administrator.
4. Enter your security PIN (login code) and press **Done**.
5. Use the ▲ up and down ▼ arrow keys to highlight **System Shutdown**. Press **Select**.
6. The current default timeout (10 minutes) setting is shown and can be used by pressing **OK** soft key. Otherwise, enter the timeout required in hours and minutes and then press the **Ok** soft key.
 - The allowable range for the timeout is from **00:00** to **24:00**. Note that a timeout of 00:00 indicates infinite (no) timeout.
 - The **Ok** soft key is not displayed if the timeout entered is not within the allowed range.
 - To enter the : symbol in the timeout press either the * or # key.
 - To delete the previous digit or character entered press the ◀ left arrow key.
7. After pressing the **Ok** soft key, you will be asked to confirm whether you want to shutdown the telephone system. Only proceed if you are sure. If you are not sure press **Back**.
8. If you press the **Confirm** soft key, the telephone system will switch itself to a shutdown state. This will disconnect all current calls and services.

21.7 Managing Memory Cards

The telephone system can be fitted with an additional memory card or cards which are used for various functions. The memory card menu allows you to check the status of the memory card or cards fitted to your telephone system and to perform a number of actions on the cards.

1. Press the **Features** soft key if shown. To do this during a call, press the  **PHONE** key and then press the **Features** soft key.
2. Use the ▲ up and down ▼ arrow keys to highlight **Phone User**. Press **Select**.
3. Use the ▲ up and down ▼ arrow keys to highlight **System Administration**. Press **Select**. If the option is not present then you may not have been configured as a system phone user by your system administrator.
4. Enter your security PIN (login code) and press **Done**.
5. Use the ▲ up and down ▼ arrow keys to scroll the display to the option **Memory Card (IP500/IP500 V2)** or **File System (Server Edition)**. The option shown varies depending on the type of telephone system.
6. The menu lists the current state of the system's memory cards and the actions that you can perform on the card.
 - The status of each memory card listed will be one of either **No Card**, **Active**, or **Inactive**. Entries are only listed for the types of cards that are supported on the telephone system to which you are connected:
 - **CF** - This refers to the optional compact flash card that can be fitted to IP500 systems.
 - **System** - This refers to the first SD memory card that must be fitted to IP500 V2 systems.
 - **Option** - This refers to the second optional SD memory card that can be fitted to IP500 V2 systems.
 - The actions that can be performed on the memory cards are listed below the status of the card or cards. The actions available depend type of card and its current status. After selecting an action, you can then select the card on which you want the action performed and then press the **Confirm** soft key to start the action.
 - **Shut Down (IP500/IP500 V2)**
This option is available when an **Active** card is present. It allows the card to be made inactive.
 - **Start Up (IP500/IP500 V2/Server Edition)**
This option is available when an **Inactive** card is present. It allows the card to be made active again.
 - **System Backup (IP500 V2/Server Edition)**
This option is available when a **System** card is present and active. It allows the telephone system's current configuration settings to be copied to a backup file on the memory card.
 - **System Restore (IP500 V2/Server Edition)**
This option is available when a **System** card is present and active. It overwrites the telephone system's current configuration settings with those from a backup file on the card.
 - **Upgrade Config (IP500 V2)**
Copy configuration files from an **Optional** card to the **System** card in the system control unit.
 - **Upgrade Binaries (IP500 V2)**
Copy software files from an **Optional** card to the **System** card in the system control unit.
 - **Copy (IP500 V2)**
This option is available on systems where both a **System** and **Option** memory card are active. It copies the contents of the **System** card to the **Option** card.

21.8 Reporting System Alarms

An **S** appearing in the [phone status letters](#)^[22] on the display indicates that a system alarm has occurred. This happens if you are configured as a system administrator (also called a system phone user).

A corresponding alarm message appears in the phone's **Status** menu. This allows you to report the problem to your system maintainer.

You can clear some alarms from the phone. When that is the case, the alarm message includes a **Clear** option. The System Status application can clear all alarms. Note however that the alarm will reoccur if the system maintainer has not resolved the original cause.

Some of the possible alarm messages are:

- **Alarm Log Entry**
This indicates that a system alarm has been recorded in the telephone system's alarm log. These can only be cleared using the System Status application.
- **Corrupt Date/Time**
There is an error in the date or time being used by the system. Selecting **Admin** takes you to the system administration menu where see the system's [date](#)^[146] and [time](#)^[146] settings.
- **Expansion Failure**
There is a problem with one of the external expansion modules attached to the telephone system.
- **Memory Card Failure**
There is a problem with one of the memory cards used by the telephone system. Selecting **Admin** takes you to the system administration menu where you can check the [status of the memory cards](#)^[150].
- **Licence Key Failure**
There is a problem with the memory card used to license features and applications.
- **System Boot Error**
The telephone system encountered an error while restarting.
- **Voicemail Failure**
The voicemail system is not available.
- **Voicemail Almost Full**
The voicemail system is nearly out of storage space for any more messages, prompts and recordings.
- **Voicemail Full**
The voicemail system cannot store any more messages, prompts and recordings.

21.9 Debug Mode

This topic is tagged for 9600 Series phones only.

In addition to backing up and restoring phone information, it is possible to enter a debug/troubleshooting mode on the 9608, 9611, 9621, and 9641 phones. In Debug Mode, you can save all applicable debug data in a file named **nnn_report.gz**, where **nnn** is replaced by the telephone extension, and then send that file to an appropriate server configured by your system administrator. You may wish to send a debug report for any of the following known issues:

- Phone resetting
- Phone going blank
- Sometimes the phone goes to speaker (and other such issues that require manually resetting the phone)
- Phone faces noise/distortion at the IPO user level (this tends to happen when a user slightly raise his/her voice)
- Lag in displaying Caller ID when on primary Call Appearance
- Freezing of phone (and other such unresponsive lock-ups)
- Contact list import via USB
- Color contrasts
- Speakerphone quality

Enabling/Disabling Debug Mode

1. While the phone is on-hook and idle, press the following sequence: **MUTE 2 7 2 3 8 # (MUTE C R A F T #)**.
2. Scroll down and select **DEBUG**. The Debug Mode menu appears.
3. The first item in the list is "Debug Mode." As the Status Line indicates, press the **Change** soft key to change the setting of Debug Mode "**On**" or "**Off**." Once a change has been made, the **Save** soft key appears.
4. Press **Save** to save the setting, or **Cancel** to return the setting to its previous state. You return to the previous menu.

Sending a Debug Report

1. While the phone is on-hook and idle, press the following sequence: **MUTE 2 7 2 3 8 # (MUTE C R A F T #)**.
2. Scroll down and select **DEBUG**. The Debug Mode menu appears.
3. Scroll to the second item in the list, "**Send report to server**" and click the **Send** soft key. Applicable debug data is sent to the server specified by your administrator in a file named **nnn_report.gz** where **nnn** is replaced by the telephone extension specified during registration. **Note:** The option "**Send report to server**" is not available if the value of **BRURI** is null or begins with any character sequence other than "**http://**" or "**https://**". See your administrator for more information.
4. If the file saves successfully, the Status Line on the display reads "**Backup successful**" for five (5) seconds or until the user takes any action on the telephone. If the debug report file cannot be saved, for whatever reason (for example, the server is not available or refuses request), the Status Line reads "**Backup failed**" for five (5) seconds or until the user takes any action on the telephone.
5. Pressing either the **Send** or **Save** soft keys will return you to the previous menu. However, when you press **Save** the telephone will conduct a reset.

Chapter 22.

Menus

22. Menus

22.1 Features Menu

This menu is accessed by pressing the **Features** soft key. It can be used to access a range of user settings.

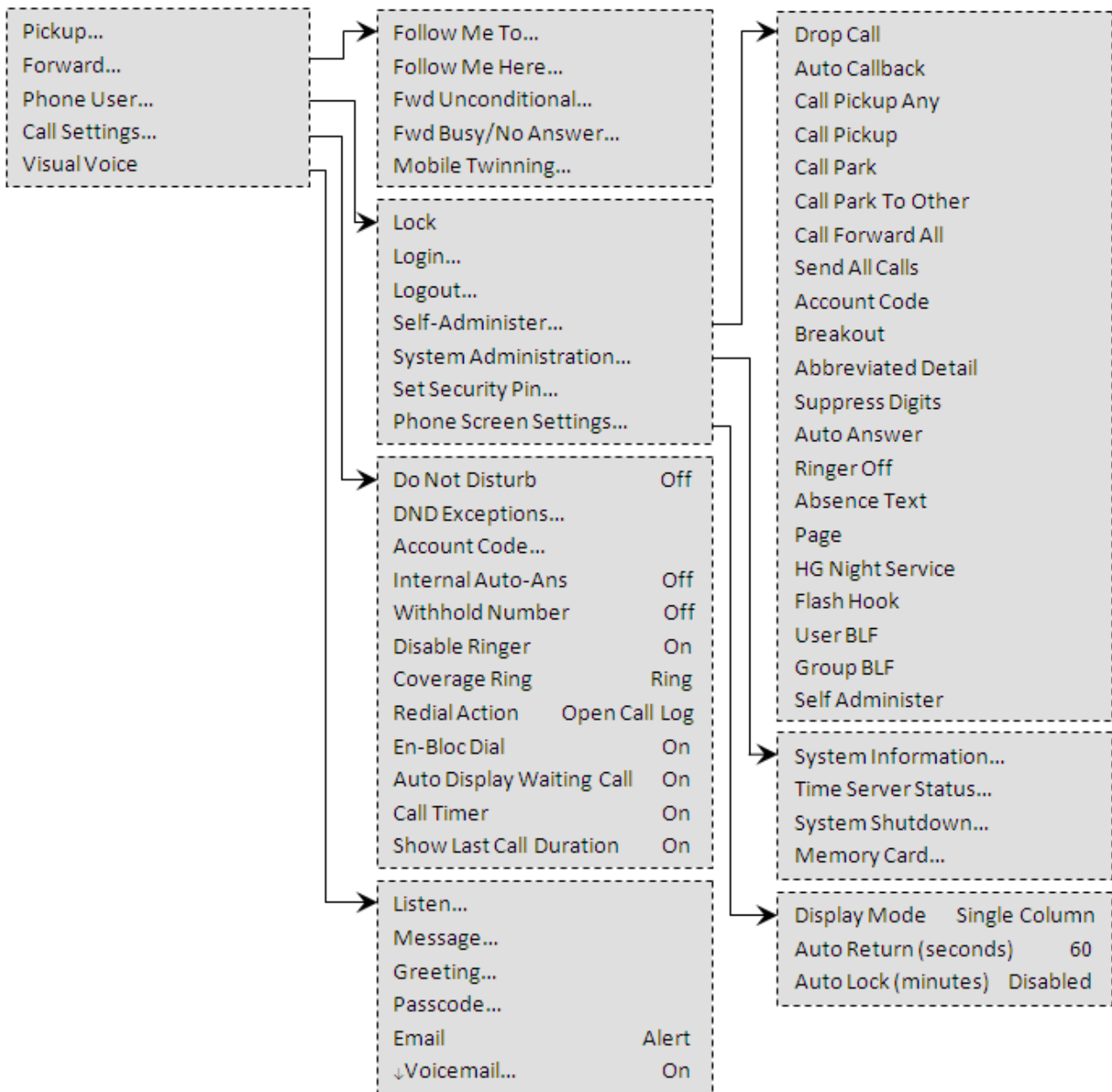

To exit the whole user menu and return to the appearance menu, press the **PHONE/EXIT** button or, if displayed, press the **Exit** soft key.

Within the menu, the ▲ up and down ▼ arrows keys are used to scroll through menu options.

When the menu option displayed has sub menus, they are indicated by the ... three dots (ellipsis) icon after the menu option name. The ◀ left and right ▶ arrow keys can be used to exit and enter sub-menus, except where they are being used to change the value of a setting (see below).

Entering a sub-menu can also be done by pressing the **Select** soft key or the **OK** button. Exiting a sub-menu can be done by pressing the **Back** soft key.

! The system administrator controls whether you can access various menus. Others are only available if certain prerequisites are met:

- While the phone is **locked** ⁸⁴, the **Features** menu cannot be accessed to change user settings.
- The system administrator is able to configure if you can access the **Membership**, **State**, and **Fallback** options of a group. If you are not configured for any groups then the **Group** menu is not shown.

- The system administrator is able to configure whether you can access the **Forward** and **Follow Me** menu and status options.
- The **Park** menu and status options are only accessible while you are talking to a caller or already have parked calls.
- The **Account Code** menu is only accessible if the system has been configured with accounts codes.
- The **Mobile Twinning** options are only shown if you have been configured to use mobile twinning.
- The **System Administration** option is only shown if you have been configured as a 'System Phone' user.

22.2 Status Menu

This menu is accessed by pressing the **Status** soft key when displayed.

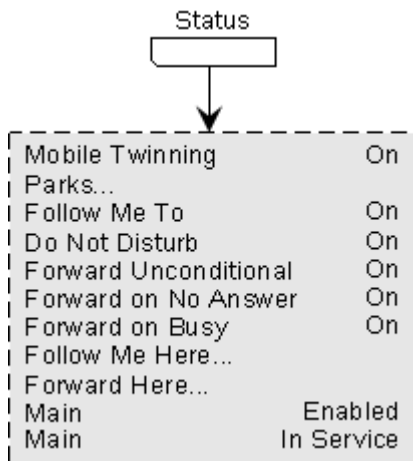

22.3 A Menu

This menu is used mainly for phone specific settings that are stored by the phone rather than settings that are stored by the phone system and move with you when you log into another phone.

The menu is accessed by pressing the **A** key. On some phones, press the **A** key and then select  **Settings**. Note that the options available vary between different models of 9600 Series telephone.

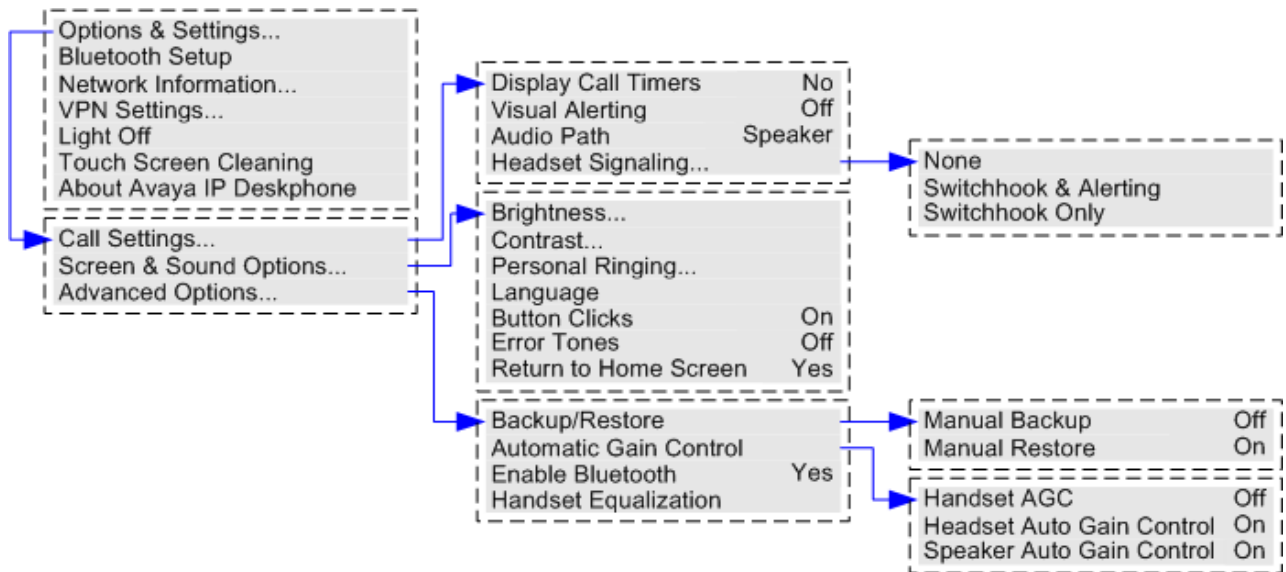

22.4 Menu Access Control

Some menu options are dynamic and only appear when appropriate. For example, the **Features** menu cannot be accessed when the phone is locked. Access to other menu options is controlled by your system administrator. They can set system wide rules for which options phone users can access. They can also set specific rules for each phone user.

Even if you are restricted from accessing an option, it may still be applied for you by your system administrator. For example, the system administrator may configure call forwarding settings for you.

The system administrator can control your menu access to the following groups of functions:

- **Basic Call Functions**
Controls whether you can access the phone's menu options for call pickup, park, unpark and transfer to mobile functions.
- **Advanced Call Functions**
Controls whether you can access the phone's menu options for do not disturb, account code, withhold number and internal auto-answer functions. In addition, the **Account Code** menu is only shown if the system has been configured with accounts codes.
- **Forwarding Functions**
Controls whether you can access the phone's menu options for forwarding and follow me functions.
- **Hot Desk Functions**
Controls whether you can access the menu options for logging in and out.
- **Passcode Change**
Controls whether you can change your login code (security credentials).
- **Phone Lock**
Controls whether you can access the menu options for locking the phone and for setting it to automatically lock.
- **Self Administration**
Controls whether you can access the Self-Administration menu option.
- **Voicemail Controls**
Controls whether you can access the **Visual Voice** option through the phone's **Features** menu. Your system administrator can also disable the Messages button from accessing the visual voice menus.
- **Group Controls**
The system administrator is able to configure if you can access the **Membership**, **State** and **Fallback** options of a group. If you are not configured for any groups then the **Group** menu is not shown.
- **Mobility Controls**
The **Mobile Twinning** options are only shown if you have been configured to use mobile twinning.

- **System Administration Controls**

The **System Admin** option is only shown if you have been configured as a 'System Phone' user.

Note that restricting menu access does not restrict access using available short codes and programmable buttons. However, those can also be removed or added by your system administrator.

22.5 Entering Characters

Entering characters for a directory search:

- When searching the directory the characters are not displayed, see [Making a Call from the Directory](#)^[64]. However, the matching names are shown as follows.
- Pressing a button enters all of the characters represented by that button. Pressing another button adds the characters from that button as the next possible characters. For example, dialing **527** simultaneously match all names starting with **JAS** (for example "Jason") and with **KAR** (for example "Karl") plus any other letter combinations from those buttons.
- To remove all the characters entered so far press **Clear**.

Entering characters for other functions:

- Select a character by re-pressing the indicated button in the charts below until the required character is displayed.
- Pressing another button enters that character and moves to entering the next character from the newly selected button.
- Pausing for more than a second after pressing a button also enters the current character and moves to entering the next character.
- You can select the text entry mode: **abc** (lower-case), **ABC** (upper-case) or **Abc** (capitalized). **123** is shown when only number entry is allowed.
- Use the left and right arrows keys to move the cursor.
- Select **Bksp** to delete the character before the cursor.

Dialing Pad Characters

General (Latin1)		
1.,@-	ABC2 ÀÁÂÃÄÅÇ	DEF3 ÐÈÉÊË
1	2	3
GHI4 Ì Î Ï Ñ	JKL 5	MNO6 Ñ Ò Ó Ô Õ Ö Ø
4	5	6
PQRS 7ß	TUV8 Ù Ú Û Ü	WXYZ9 Ý Þ ÿ
7	8	9
*	_0	#
*	0	#

French			German		
1.,@-	ABC2 ÀÁÂÃÇ	DEF3 ÉÊËË	1.,@-	ABC2 ÄÁÂÃÇ	DEF3 ÉÊËË
1	2	3	1	2	3
GHI4 Î Ï Ñ	JKL 5	MNO6 Ñ Ò Ó Ô Ö	GHI4 Í Î Ï Ñ	JKL 5	MNO6 Ñ Ò Ó Ô Ö
4	5	6	4	5	6
PQRS 7	TUV8 Ù Ú Û Ü	WXYZ 9	PQRS 7ß	TUV8 Ù Ú Û Ü	WXYZ 9Ý
7	8	9	7	8	9
*	_0	#	*	_0	#
*	0	#	*	0	#

Italian			Portuguese		
1.,@-	ABC2 ÀÁÂÃÇ	DEF3 ÉÊËË	1.,@-	ABC2 ÁÂÃÄÅÇ	DEF3 ÉÊËË
1	2	3	1	2	3
GHI4 ÌÎÏÏ	JKL 5	MNO6 ÑÓÔÕÖ	GHI4 ÍÎÏÏ	JKL 5	MNO6 ÑÓÔÕÖÖ
4	5	6	4	5	6
PQRS 7ß	TUV8 ÚÛÜÛ	WXYZ 9	PQRS 7ß	TUV8 ÚÛÜÛ	WXYZ 9
7	8	9	7	8	9
*	_0	#	*	_0	#
*	0	#	*	0	#

Russian			Spanish		
1.,@-	АБВГ ABC2	ДЕЖЗ DEF3	1.,@-	ABC2 ÁÂÃÄÅÇ	DEF3 ÉÊËË
1	2	3	1	2	3
ИЙКЛ GHI4	МНОП JKL5	РСТУ MNO6	GHI4 ÍÎÏÏ	JKL 5	MNO6 ÑÓÔÕÖÖ
4	5	6	4	5	6
ФХЦЧ PQRS7	ШЩЪЫ TUV8	ЬЭЮЯ WXYZ9	PQRS 7ß	TUV8 ÚÛÜÛ	WXYZ 9
7	8	9	7	8	9
*	_0	#	*	_0	#
*	0	#	*	0	#

Chapter 23.

Glossary

23. Glossary

23.1 Abbreviated Ring

A single non-repeated ring. By default, this is the type of ring used when another call alerts you and you already have a call in connected.

23.2 Appearance Button

Appearance buttons are used to represent calls made and received by you and other users on the telephone system. They are configured by your system administrator. Normally, your first three buttons are call appearance buttons, but additional buttons can be configured as appearance buttons.

23.3 Attention Ring

Your system administrator can set what ringing should be used if another call alerts you and you already have a call connected. The options are a single non-repeated ring (abbreviated ring) or no ring.

23.4 Auto Hold

By default, when you have a connected call in progress, if you press another appearance button, the connected call is automatically put on hold. Without auto-hold, pressing another appearance button ends the connected call.

23.5 Bridged Appearance Button

A bridged appearance button shows the state of one of another user's call appearance buttons. It can be used to answer or join calls on that other user's call appearance button. It can also be used to make a call that the call appearance user can then join or retrieve from hold.

- When the user's call appearance button alerts, your matching bridged appearance button also alerts. The bridged appearance button can be used to answer the call on the call appearance button user's behalf.
- When the call appearance button user answers or makes a call using that call appearance, your matching bridged appearance button shows the status of that call, for example connected, on hold, etc. The bridged appearance button can be used to retrieve the call if on hold or to join the call if active.
- Bridged appearance buttons are not supported between users on different systems in a [SCN](#) ^[165].

23.6 Call Appearance Button

Call appearance buttons are used to display calls to and from your phone. By having several call appearance buttons, you are able to answer and make several calls, switch between calls, and perform other actions.

When all your call appearance buttons are in use, any further calls to your number follow your 'forward on busy' setting, if set. Otherwise, calls go to voicemail (if available).

23.7 Call Coverage Button

Each call coverage button is associated with another user on your telephone system. The button allows you to be alerted when that user has an unanswered call still ringing. You can view the details of the call and answer it if required.

The settings of the user being covered control how long it rings at their phone before it also starts alerting on your call coverage button for that user. Call coverage appearance buttons are not supported between users on different systems in a [SCN](#) ^[165].

23.8 Coverage Ring

If you have any bridged appearance and or call coverage buttons, you can [set the type of ringing \(coverage ring\)](#) ^[124] that should be used when a call alerts on any of those buttons. The options are to use normal ringing, a single non-repeated ring (abbreviated ring) or no ring. The coverage ring setting is only used if you do not already have a connected call. If you already have a connected call in progress, the shorter of the coverage ring and attention ring settings is used.

23.9 Do Not Disturb

- When you are in 'do not disturb,' your callers are redirected to voicemail if available. Otherwise, you hear a busy tone.
- The only people who can call you are those calling from numbers in your 'do not disturb' exceptions list. Forwarding can still be applied to these calls.
- Calls to any hunt group of which you are a member are not presented to you (unless you are the last available member of the group).
- Enabling 'do not disturb' will not affect any calls already being presented to your phone.
- You can still use the phone to make outgoing calls. When you go off-hook you will hear broken dial tone.
- **N = No Calls (Do Not Disturb)**
An **N** is shown after your extension name on the phone's idle display when you have 'do not disturb' enabled.

23.10 Do Not Disturb Exceptions

- These are numbers for callers who can call you even when you are set to 'do not disturb.' This only applies for calls to you. It does not apply for calls to a hunt group of which you are a member.

23.11 Follow Me

'Follow me to' is used to redirect your calls to another extension where you will be working. The calls are presented with your user name so that they can be distinguished from calls for the extensions normal user. This allows you to share another person's phone without logging them off their phone.

All calls are redirected and the calls are still subject to all your user settings as if they were ringing at your phone.

23.12 Follow Me Here

'Follow me here' is the function used to enable 'follow me' at the extension to which you want your calls redirected.

23.13 Follow Me To

'Follow me to' is the function used to enable 'follow me' from your own phone.

23.14 Forward on Busy

'Forward on busy' redirects your calls when your phone is not able to present you with any more alerting calls.

- By default, this function is only applied to incoming external calls made to you. However, if required, internal calls can also be selected.
- When enabled, all calls matching the settings are forwarded to the number set as the 'forward on busy'/'no answer' destination. That number can be internal or external.
- 'Busy' is defined as having no available call appearance buttons on which further calls can be presented.
- Hunt group calls are not presented when you are busy and so are not forwarded by this setting.
- The 'forward on busy' and 'forward on no answer' options use the same forwarding destination number. If no number is set, they use the same destination as set for 'forward unconditional.'
- If you have [voicemail enabled](#) ⁽⁷⁹⁾, the telephone system will attempt to redirect forwarded calls to voicemail if they are still unanswered after having rung for your 'no answer' time (default 15 seconds). This is not always possible for calls that have been forwarded to an external number.

23.15 Forward on No Answer

Forward on no answer redirects calls that have alerted your phone but have not been answered.

- By default this function is only applied to incoming external calls to you. However, if required, internal calls can also be selected.
- When enabled, all calls matching the settings are forwarded to the number set as the 'forward on busy'/'no answer' destination. That number can be internal or external.
- No answer is defined as having been presented to your phone for your 'no answer' time (default 15 seconds).
- Hunt group calls are not forwarded.
- The 'forward on busy' and 'forward on no answer' options use the same forwarding destination number. If no number is set, they use the same destination as set for 'forward unconditional.'
- If you have [voicemail enabled](#) ⁽⁷⁹⁾, the telephone system will attempt to redirect forwarded calls to voicemail if they are still unanswered after having rung for your 'no answer' time (default 15 seconds). This is not always possible for calls that have been forwarded to an external number.

23.16 Forward Unconditional

Forward unconditional can be used to immediately redirect your calls.

- By default this function is only applied to incoming external calls made to you. However, if required, internal calls and or hunt group calls can also be selected.
- When enabled, all calls matching the settings are forwarded to the number set as the 'forward unconditional' destination. That number can be internal or external.
- You can still use the phone to make outgoing calls. When you go off-hook you will hear broken dial tone.
- The 'forward on busy' and 'forward on no answer' options use the same forwarding destination number. If no number is set, they use the same destination as set for 'forward unconditional.'
- If you have [voicemail enabled](#) ⁽⁷⁹⁾, the telephone system will attempt to redirect forwarded calls to voicemail if they are still unanswered after having rung for your 'no answer' time (default 15 seconds). This is not always possible for calls that have been forwarded to an external number.

- **D = Diverting (Forwarding) Calls**

A **D** is shown after your extension name on the phone's idle display when you have 'forward unconditional' enabled.

23.17 Group

Your system administrator can include you as a member of a group along with other users. Each group has its own extension number which can be used as the destination for a call.

When a call is made to a group, it is presented to the available group members, either one at a time or all at the same time, until answered by one of the members.

How long a group call will ring at each group member before being presented to the next member is controlled by the group's own settings. Hunt groups also use voicemail and have their own settings for when an unanswered call should go to the group's mailbox. For group calls, the hunt group's voicemail settings are used rather than your settings.

23.18 Idle Line Preference

Having one of your phone's call or line appearance buttons set as the currently selected appearance button means it will be the appearance button used when you go off hook. If this was not the case, you would need to select an appearance button before going off hook.

Idle line preference automatically selects the first available call appearance or line appearance button as your currently selected button when you do not have a call connected.

23.19 Internal Twinning

This method of twinning twins your normal phone with another internal phone. Your incoming calls will ring on both phones. You can also make your calls from either extension.

A typical example for internal twinning would be a user who uses both a normal desk phone and also needs a mobile phone while moving around the building.

Your settings are applied to both phones. Similarly, message waiting indication and voicemail access from either phone will be to your mailbox.

If both phones are phones that store your contacts and call history on the system, the contacts and call history on each will be the same.

23.20 Line Appearance Button

Line appearance buttons allow you to make and receive calls on a specific telephone line connected to your telephone system. The button also allows you to see when the line is in use by other users.

For incoming calls, the telephone system still determines the destination for the call. That may be a user or group. However, if you have a line appearance button for the line, you will see that there is a call alerting and can answer it if required.

- **Private Lines**

Special behaviour is applied to calls where the user has both a line appearance for the line involved and is also the Incoming Call Route destination of that call. Such calls will alert only on the Line Appearance button and not on any other buttons. These calls will also not follow any forwarding.

23.21 Logged Out

If you are logged out from any phone, you are treated as being busy to receiving any calls. Callers follow your forwarding settings if set or go to voicemail if available.

23.22 Missed Call

Missed calls are calls that ring at your phone but are not answered. Your 10 most recent missed calls are included in your call log (on 9608, 9611, 9621, and 9641 phones, your 30 most recent missed calls are included in your call log).

The system administrator can configure whether missed calls should include calls that you did not answer but were answered for you by another user; for example, by a user with a call coverage button set for your calls. If this mode is enabled, it will also include calls that were answered by your voicemail.

23.23 Missed Group Call

The system administrator can configure whether the telephone system should keep an internal log of missed hunt group calls. They can then also set which groups of which you are a member, should have their missed calls shown as part of your missed calls call log. This does not require the group call to have been presented to you and missed.

23.24 Login Code

You can use a login code to log in at any phone on the telephone system and then use that phone as your own. While logged in, you can use the phone's menus to set and change your login code.

23.25 Mobile Twinning

Mobile [twinning](#)^[165] allows your calls to ring at both your phone's and at another phone's number, which can include an external number. If you have been configured as a mobile twinning user, you can switch the use of mobile twinning on or off through the phone's menus and can also change the number to which you are twinned.

23.26 Park Call

Parking a call is similar to holding a call. However, parked calls can be retrieved by other users on the telephone system.

A call that you park and leave parked for too long will recall to your phone. The recall will ignore any 'do not disturb' and forwarding settings, recalling to the phone from which it was parked.

23.27 Park Slot Number

If you park a call without specifying a park slot number, the system will assign a number based on your extension number plus a single digit. For example for extension 201, the first parked call will use park slot number 2010 if available. If you already have a parked call, the next parked call uses park slot 2011 if available and so on up to 2019.

Call park buttons can be configured to match specific park slot numbers. A call parked using that button is given that park slot number. All users with a call park button set to the same number can see when there is a parked call there and can unpark that call using their button.

23.28 Ringing Line Preference

This setting is controlled by your system administrator and is normally on. When you are not connected to a call, if you receive an incoming call, ringing line preference will make the alerting appearance button your selected appearance button. You can answer the call on the selected appearance button by lifting the handset or pressing the **Headset** or **Speaker** button.

Without ringing line preference, to answer the call on the alerting appearance button you must press the appearance button to select it manually.

23.29 Short Codes

Short codes are numbers that you can dial to enable and disable various features. The following are default short codes that may be available. However, your system administrator can remove and change the short codes available to you or all users.

23.30 Small Community Network

Several telephone systems can be connected together to form a [Small Community Network \(SCN\)](#)^[163]. You can then dial the user on other systems in the same way as for internal calls on your own system. The remote users are listed in the directory.

The system administrator can also configure which hunt groups are accessible across the network. You may also be able to hot desk to a phone located on another system in the network.

23.31 System Administrator

The system administrator is able to make or arrange changes to the telephone system configuration. They are able to see and change most of your user settings.

23.32 System Phone User

Your system administrator can configure some users as 'system phone users.' They will be able to access a range of additional functions such as changing the system date and time. A 'system phone user' is able to add, edit, and delete system directory entries.

23.33 Twinning

Twinning is a process whereby your calls ring on two phones. Twinning is only available if configured by your system administrator.

The system supports two twinning methods: [internal twinning](#)^[164] and [mobile twinning](#)^[165].

Chapter 24.

Document History

24. Document History

Date	Issue	Changes
14th January 2015	10a	<ul style="list-style-type: none">• Source restructure for Japanese rebranding.• Greenwashed.• Corrected missing Auto Lock topic.
22nd January 2015	10b	<ul style="list-style-type: none">• Continued source restructure for Japanese rebranding.
13th April 2015	10c	<ul style="list-style-type: none">• Add Alarm Log Entry to the system alarms plus description of how alarms are cleared.
1st May 2015	10d	<ul style="list-style-type: none">• Replace 'quiet' with 'silence'.
18th May 2015	10e	<ul style="list-style-type: none">• Minor note, need to move power switch to H position when attaching any external device such as button module.
22nd May 2015	10f	<ul style="list-style-type: none">• Update the Ring Sound ^[122] section.
21st July 2015	10g	<ul style="list-style-type: none">• Added Bluetooth ^[58] notes to 9600 telephone guide.• Added a page for Dropping incoming calls ^[33].
22nd July 2015	10h	<ul style="list-style-type: none">• Drop cannot be used for hold and park returns.
7th August 2015	10i	<ul style="list-style-type: none">• Additional clarification and corrections to ring tone selection ^[122] options.
24th August 2015	10j	<ul style="list-style-type: none">• Additional keypad character mapping details ^[158] added.

Index

A

Abbreviated ring 124, 162
 Access Control
 Fallback 103, 104, 105, 106, 139
 Follow Me 29, 34, 41, 47, 50, 75, 76, 83, 84, 85, 90, 93, 94, 95, 97, 99, 108, 119, 121, 124, 136, 137, 138, 140
 Forward 29, 34, 41, 47, 50, 75, 76, 83, 84, 85, 90, 93, 94, 95, 97, 99, 108, 119, 121, 124, 136, 137, 138, 140
 Membership 103, 104, 105, 106, 139
 State 103, 104, 105, 106, 139
 Add
 Contact 65, 71
 External contact 62, 65, 66
 to conference call 52
 Alarm 140, 151
 All
 Call Log 28, 65, 69, 70, 71
 Contacts 28, 63, 64
 Forward 93, 138
 All Calls 93, 138
 Almost Full 140, 151
 A-Menu 118, 156
 Answered 28, 65, 69, 70, 71
 Attention Ring 122
 Audio Path 57, 60, 131
 Auto-Answer 124
B
 B 22
 Backup
 Manual backup 132
 Barred 22
 BM32 20
 Boot Error 140, 151
 Bridged appearance
 Coverage ring 124, 162
 broken dial tone 91, 96, 162, 163
 Busy
 Forward 94, 95, 137, 138
 Button Module 20
C
 Call
 from Call Log 28, 69
 from Contacts 28, 64
 from redial list 29, 36
 Call coverage
 Coverage ring 124, 162
 CALL LOG 28, 65, 69, 70, 71
 Call from 28, 69
 Details 70
 Menu 68
 Call Settings 26, 29, 36, 50, 97, 119, 120, 121, 124, 126, 127
 Audio Path 57, 60, 131
 Auto-Answer 124
 Internal Auto-Answer 124
 Visual alerting on/off 124
 Withhold number 29, 119
 Call Waiting 127
 Caller
 Details 70
 Conference
 Add call 52

 Caller details 52, 53
 Drop caller 52, 53
 End automatically 52, 53
 Hold 39, 53
 Last internal user 52, 53
 Music on hold 39, 53
 Contact
 Add 65, 71
 add external 62, 65, 66
 delete external 62, 65, 66
 Edit 65, 66
 edit external 62, 65, 66
 CONTACTS 28, 62, 63, 64, 65, 66
 Make call 28, 64
 Corrupt Date/Time 140, 151
 Count 70
 Coverage ring 122, 124, 162
 CPkUp 41, 140
D
 D 22, 91, 163
 Date 147
 Daylight Saving 147
 Delete
 External contact 62, 65, 66
 Follow me here 90, 137
 Details
 Call Log 70
 Dial tone
 Broken 91, 96, 162, 163
 Directory
 Add 65, 71
 add external 62, 65, 66
 delete external 62, 65, 66
 Edit 65, 66
 edit external 62, 65, 66
 Make call 28, 64
 Display
 Call Waiting 127
 Divert
 To voicemail 33, 79
 Diverting 22, 91, 163
 Do Not Disturb 22, 96, 162
 Off 97, 136
 Status 97, 136
E
 Edit
 Contact 65, 66
 External contact 62, 65, 66
 Follow me here 90, 137
 En-bloc 26, 120
 En-Bloc Dial 26, 120
 Expansion Failure 140, 151
 External 28, 63, 64
 Forward 93, 138
 Forward on Busy 94, 95, 137, 138
 External and Group 93, 138
 External Calls 122
 external directory 62, 65, 66
 External Only 93, 138
F
 Failure 140, 151
 Features
 Menu 154
 Follow me here
 Clear 90, 137

Follow me here
 Edit 90, 137
 Off 137
 Status 137
Follow Me To
 Off 90, 136
 Status 90, 136
Forward
 All Calls 93, 138
 External and Group 93, 138
 External Only 93, 138
 Non Group Calls 93, 138
 Off 93, 138
 on Busy 94, 95, 137, 138
Forward on Busy
 Off 95, 137
 Status 95, 137
Forward on No Answer
 Off 94, 138
 Status 94, 138
Forward Unconditional 93, 138
 Off 93, 138
 Status 93, 138
Forwarded to Here
 Off 138
 Status 138
Forwarding 22, 91, 163
Full 140, 151
Fwd To Here 138

G

G 22
Group
 Call log 68
 Forward 93, 138
 Membership status 103, 139
 Missed 68
 Service status 104, 105, 139
Group Member 22
Groups 28, 63, 64

H

Handset
 Volume 131
Headset
 Volume 57, 131
Held call
 Transfer 40, 47
Hold
 Conference 39, 53
 Transfer 40, 47
Hunt group
 Call log 68
 Forward 93, 138
 Membership status 103, 139
 Missed 68
 Service status 105, 139

I

In Service 104, 105, 139
Internal Auto-Answer 124
Internal Calls 122

L

Lamp 124
List 36, 119
Local Time 147
Login 83

M

Make call
 from Call Log 28, 69
 from Contacts 28, 64
 from redial list 29, 36
Manual
 Restore 132
Memory Card Failure 140, 151
Menu
 A-Menu 118, 156
 Call log 68
 Contacts 62
 Features 154
 Status 155
 Status menu 136
Message waiting lamp 124
Missed 28, 65, 69, 70, 71
Missed calls
 Hunt group calls 68
Mobile Twinning
 Number 98, 119
 Off 99, 139
 On/Off 98, 119
 Status 99, 139
More 69, 70, 75, 77, 78
Music on hold 39, 53

N

N 22, 96, 162
New
 Contact 65, 71
Night Service
 Automatic 104, 105, 139
No answer
 Forward status 94, 138
No Calls 22, 96, 162
No ring 124, 162
Non Group Calls 93, 138

O

O 22, 104
One 36, 119
OOS 104, 105, 139
Out of Service 22, 104, 105, 139
Outgoing 28, 65, 69, 70, 71

P

Parked calls
 Status 41, 140
Password 83
Personal 28, 63, 64
Phone User 84, 85, 108, 115, 121, 128, 146, 147, 148, 149, 150

R

R 22
Reason 70
Redial 29, 36
 List 29, 36
Redial mode 36, 119
Resilience 22
Restore 132
Ring
 Attention Ring 122
 Coverage Ring 122
 External Calls 122
 Internal Calls 122
 Ringback 122

Ring Time 70
Ringback 122
Ringer
 Volume 124, 130

S

S 22
SBM32 20
Send All Calls 93, 138
Speaker
 Volume 60, 131

Status
 Do Not Disturb 97, 136
 Follow Me here 137
 Follow Me To 90, 136
 Forward on Busy 95, 137
 Forward on No Answer 94, 138
 Forward unconditional 93, 138
 Forwarded to Here 138
 Group membership 103, 139
 Group service status 105, 139
 Hunt group service status 105, 139
 Membership 103, 139
 Menu 155
 Mobile twinning 99, 139
 Parked calls 41, 140
 Service status 105, 139

Status menu 136
System Administrator 140, 151
System Alarm 22, 140, 151
System Boot Error 140, 151
System Phone 62, 65, 66, 140, 151

T

T 22, 98
Time 147
Time profile 104, 105, 139
Time Server 147
Transfer
 Held call 40, 47
 To voicemail 33, 46, 79

Twinned 22, 98
Twinning
 Number 98, 119
 Off 99, 139
 On/Off 98, 119
 Status 99, 139

U

Users 28, 63, 64
UTC Time 147

V

Visual Alerting 124
Voicemail
 Transfer 33, 46, 79
Voicemail Almost Full 140, 151
Voicemail Failure 140, 151
Voicemail Full 140, 151
Volume
 Handset 131
 Headset 57, 131
 Ringer 124, 130
 Speaker 60, 131

W

Waiting Call 127
Withhold Number 29, 119

Performance figures and data quoted in this document are typical, and must be specifically confirmed in writing by Avaya before they become applicable to any particular order or contract. The company reserves the right to make alterations or amendments to the detailed specifications at its discretion. The publication of information in this document does not imply freedom from patent or other protective rights of Avaya or others.

All trademarks identified by the ® or ™ are registered trademarks or trademarks, respectively, of Avaya Inc. All other trademarks are the property of their respective owners.

This document contains proprietary information of Avaya and is not to be disclosed or used except in accordance with applicable agreements.

© 2015 Avaya Inc. All rights reserved.